



2023 TRANSPORTATION PRODUCTS







# The Industry Standard

For over 30 years, National Products Inc. supplies the most rugged and connective mobile device mounting systems on the planet. With the globally recognized RAM® Mounts and award-winning GDS® Tech™, and IntelliSkin® product lines, NPI's mission to bring world-class mounting solutions to real-world applications have become essential to success in almost all industries — we are the industry standard.

## SEEN IN THIS PHOTO:

### RAM-B-101-225B2-SAM60P-V7B1U

RAM® EZ-Roll'r™ Powered Dock with Dashboard Mounting Kit for Samsung Tab Active3







# Contents

- 4 | About RAM® Mounts
- 5 | The Connected Highway
- 7 | Transportation & Logistics
- 9 | Last Mile Delivery
- 11 | Student Transportation **NEW**
- 13 | Waste Management **NEW**
- 15 | Accessories & Add-Ons **NEW**
- 19 | Hardwire Chargers
- 21 | Universal Holders







# About RAM® Mounts

RAM® Mounts manufactures rugged and versatile mounting systems for phones, tablets, and other mobile devices that can be attached nearly anywhere. Unlike other mounts on the market, RAM® allows you to secure devices where you need them most. The unique design of the RAM® Mounts system provides quick installation, adjustability, strength, vibration damping, and durability—all at a low cost. Backed by a lifetime warranty, RAM® uses powder-coated, marine-grade aluminum with lightweight and high-strength composites, stainless steel hardware, and rubber balls.

## The RAM® Difference



### Premium Design

The rubber ball and socket design of our mounting systems offers a secure hold, with near-infinite adjustability and vibration damping for the most demanding environments. With thousands of components trusted by users around the world, we've been able to design and develop mounting solutions that consumers and companies previously only dreamed were possible.



### Customizable

Take your phone mount from your truck to your boat, or mix and match components to create your ideal mount. Because of the modularity of the RAM® system, you can customize your solution to fit your specific needs in almost any application.

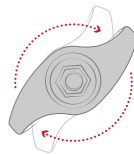

### Quality Materials

A premium design deserves the highest quality materials available, from rubber and stainless steel to high-strength composites and marine-grade aluminum. Our facilities— including powder coating, die casting, rubber injection molding, and shock and vibration testing—help us deliver on this promise to bring you inventive mounting solutions.



### Lifetime Warranty

It's simple. Our reputation as the leader of premier mounting systems means if we build it, then we guarantee it. We're confident in the quality of our products, and with our warranty, you can be too.

\*1-3 year warranty on electronics, including powered docks

## National Products Inc. (NPI)

Introduced in 1990, National Products Inc. (NPI) quickly became the leading manufacturer of rugged and versatile mounting solutions. RAM® Mounts has grown to offer approximately 5,000 modular components—the most innovative product line of its kind for nearly any application and device, including phones, tablets, GPS systems, laptops, marine electronics, printers, radios, and much more.

In addition to RAM® Mounts, NPI is also the creator of award-winning IntelliSkin® sleeves and GDS® Technology™ products. IntelliSkin® sleeves ruggedize a wide range of consumer phones and tablets, while the GDS® Ecosystem™ provides users the ability to securely charge, dock, and sync devices in the most demanding environments.

NPI is proudly located in Seattle, Washington in the same neighborhood where the company was started.

## Partner with RAM® Mounts

Here at RAM® Mounts, we believe that unfathomable things are possible with ingenuity. With a portfolio of more than 5,000 SKUs paired with innovative engineers and in-house product experts, we have the tools and expertise needed to create solutions that you didn't know were possible. We have the ability to solve your mounting challenges quickly, efficiently, and cost effectively.



# Welcome to The Connected Highway

For the last few decades, RAM® Mounts has collaborated with the industry's best innovators to build the future of mobility. The key to a mobile workforce combines device, software, and docking solution. That's why we created The Connected Highway — a commitment to making the most reliable and affordable device mounts, paired with the best solutions providers in the world. Every day our engineering teams look for ways to optimize product performance to seamlessly integrate into one another, making the lives of drivers all around the world easier, and business logistics scalable.



**CONNECTED  
HIGHWAY**



## Device

Every journey starts with a device. Without an ELD, the new age of the connected worker isn't possible.





### Software

Industry standard ELD software insures compatibility across the device and docking station.

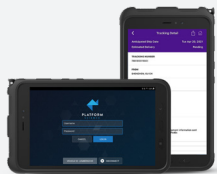

### Docking Station

RAM® Mounts ties the entire solution together with a wide variety of device specific powered docking stations.

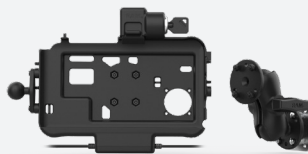



# Transportation & Logistics

When deploying thousands of ELDs, purchasing the right dock should be a no-brainer. That's why RAM® offers turnkey, rugged, cost-effective mounting solutions for ELD compliance. Depending on what device you are deploying, RAM® will either have the right solution ready to go, or build the right kit for you. Take advantage of upgrades like peripheral support, add-on accessories, and the award winning GDS® Tech™ for connective longevity and reliability.

## KITS INCLUDE



Cable Management



Hardwire Charger



**RAM-HOL-SAM60P-V7B1U**  
RAM® Non-Locking Kit  
for Samsung Galaxy Tab Active3



**RAM-101-B-225B2U**  
RAM® Drill-Down  
Dashboard Mount  
with Backing Plate - C Size



**CONNECTED  
HIGHWAY**

### Devices

Samsung  
Zebra  
Apple

### Software

Platform Science  
Solera  
Trimble

SCAN OR  
CLICK TO SEE →  
ELD KITS



## SEEN IN THIS PHOTO:

**RAM-B-101-225B2-SAM60P-V7B1U**  
RAM® EZ-Roll'r™ Powered Mount  
for Samsung Tab Active3



# Choose Your Kit

We've done the thinking, so you don't have to.

**NEW**



### RAM-HOL-SAM60P-V7B1U

RAM® Non-Locking Kit  
for Samsung Galaxy Tab Active3

### CLICK TO ADD

RAM® Low-Profile Kit  
for Samsung Galaxy Tab Active3

### CLICK TO ADD

GDS® Tough-Dock™ Kit  
for Samsung Galaxy Tab Active3

**NEW**



### RAM-GDS-101B2-SAM80CP-V7B1U

GDS® Tough-Dock™ Kit for  
Samsung Galaxy Tab A7 Lite 8.7"

### CLICK TO ADD

RAM® Tough-Dock™ Kit  
for Zebra ET4x 8" Tablet

### CLICK TO ADD

GDS® Vehicle Dock Kit  
for Apple iPad mini 6

All kits are ELD Compliant



**PLATFORM  
SCIENCE**

RAM® Mounts partners with Platform Science telematics software to bring you easy turnkey ELD Solutions.

**LEARN MORE**



INTRO  
CONNECTED HIGHWAY  
T & L  
LAST MILE DELIVERY  
STUDENT TRANSPORTATION  
WASTE MANAGEMENT  
ACCESSORIES  
CHARGERS  
UNIVERSAL





**SEEN IN THIS PHOTO:**

**RAM-HOL-ZE7U**

RAM® Form-Fit Powered Dock for Zebra TC70, 72, 75 & 77

# Last Mile Delivery

Delivery companies rely on long-lasting powered docking stations that keep devices charged and can withstand numerous docking occurrences throughout a long day. To build confidence with our customers, each RAM® dock is cycle tested to ensure upwards of 100,000 insertions throughout each device's life cycle. RAM®'s commitment to becoming the industry standard means supporting all the newest devices paired with the continued promise of a lifetime warranty on all mounting components.



**RAM-HOL-ZE7-NPU**  
RAM® Form-fit Dock for Zebra TC70, 72, 75, 77

## Recommended Docks

**NEW**



**RAM-HOL-ZE17L-2U**  
RAM® Key-Locking Powered Dock for Zebra TC53 & TC58

**NEW**



**RAM-HOL-ZE17-1U**  
RAM® Powered Dock for Zebra TC73 & TC78

**NEW**



**RAM-GDS-DOCK-V11CU**  
GDS® Vehicle Phone Dock for Samsung XCover6 Pro

**NEW**



**RAM-HOL-SAM84CP-1U**  
RAM® EZ-Roll™ Powered Dock for Samsung XCover6 Pro with Samsung Smart Case or RAM® Skin™





**SEEN IN THIS PHOTO:**

**RAM-GDS-DOCK-V11CU**  
 GDS® Vehicle Phone Dock for Samsung XCover6 Pro

**RAP-B-299-4-201U**  
 RAM® Stubby™ Cup Holder Mount with Double Socket Arm

**Recommended Bases**



**RAM-101U**  
 RAM® Double Ball Mount Drill-Down C-Size



**CLICK TO VIEW**  
 RAM® Stubby™ & RAM-A-CAN™ II Cup Holder Bases



**CLICK TO VIEW**  
 RAM® Twist-Lock™ Suction Cup Bases



**RAM-316-HD-18-202U**  
 RAM® Pod HD™ Floor Mount with 18" Aluminum Rod

**Commonly Found**





# Student Transportation

## New RAM® NFC Reach™

RAM® Mounts takes NFC scanning to the next level with the brand new RAM® NFC Reach™ by adding an NFC repeater to your Samsung Galaxy Tab Active3. With this NFC repeater, tablet operators no longer need to remove the device from its docking station to scan — simply install the repeater on your docking station and give easy access to programs used to track student ridership, vehicle inspections, and more.



**CONNECTED  
HIGHWAY**

### Devices

Samsung

### Software

SMART tag™	QRyde
TylerTech	Treker
Zonar	RideZum
EDULOG	BusRight



### RAM-HOL-SAM60P-NFCU

RAM® Powered Dock for Tab Active3 with RAM® NFC Reach™



### RAM-GDS-DOCK-SAM62CDU

GDS® Tough-Dock™ + Single USB for Samsung Galaxy Tab Active3



### RAM-GDS-DOCKL-SAM62CP-NFCU

Locking GDS® Tough-Dock™ for Tab Active3 with RAM® NFC Reach™



### RAM-B-102-NFCU

RAM® NFC Reach™ NFC Extender with Double Ball Mount

### RAM-GDS-DOCK-SAM62CP-NFCU

GDS® Tough-Dock™ for Tab Active3 with RAM® NFC Reach™

### SEEN IN THIS PHOTO:

#### RAM-HOL-SAM60P-NFCU

RAM® Powered Dock for Samsung Tab Active3 with RAM® NFC Reach™

#### RAM-B-140U

RAM® Double Ball Mount Drill-Down B-Size with 2-hole & 4-hole AMPS Plates

#### RAM-101-225B2U

RAM® Drill-Down Dashboard Mount with Backing Plate - C Size Medium







### Simplify Your Solution

Don't need all the bells and whistles? We've got a simple turnkey Tab Active3 docking station utilizing the tablet's built-in pogo pads and a RAM® Powered Dock to tackle your bus routes.

- ◀ **RAM-B-101-225B2-SAM60P-V7B1U**  
RAM® EZ-Roll'r™ Powered Mount for Samsung Tab Active3 & 2



### Upgrade Your Connection

With the durability and reliability of GDS® Technology™, utilizing pogo-pin connectivity can save drivers daily hassle and prevent longterm damage caused by frequent docking and undocking.

- ◀ **RAM-GDS-101B2-SAM80CP-V7B1U**  
GDS® Tough-Dock™ Vehicle Bundle for Samsung Tab A7 Lite 8.7"



RAM® Mounts partners with SMART tag™ software to bring you the next generation of student on-board tracking.

### VIEW CASE STUDY

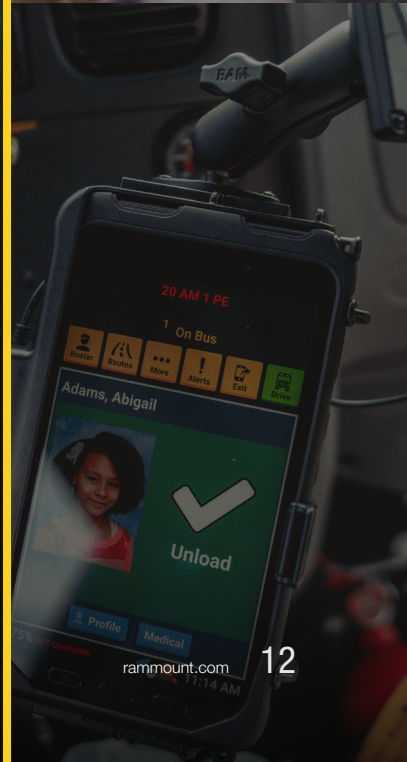





**SEEN IN THIS PHOTO:**

**RAM-GDS-DOCK-SAM62CU**

GDS® Tough-Dock™ + Data Sync for Samsung Tab Active3

**RAM-101U-B**

RAM® Short Double Ball Mount Drill-Down C-Size





# Waste Management

The logistics of waste disposal is a dirty job, and the landscape of the business requires more efficient mobile devices to get the job done. That's why more enterprise businesses have been switching to the GDS® Tech™ platform. The combination of RAM® Mounts, GDS® Docks™, and IntelliSkin®-wrapped devices ruggedize the entire solution — built to withstand this unsanitary work environment. With pogo pin technology being the centerpiece of the GDS® Ecosystem™, trust is well-established once drivers recognize that port protection is the key component to connective longevity.



## Recommended Docks



**RAM-GDS-DOCK-SAM54CPU**  
 GDS® Tough-Dock™ for Samsung Galaxy Tab Active4 Pro



**RAM-HOL-ZE10PD2KLU**  
 GDS® Key-Locking Powered Dock for Zebra ET56 8.4" Tablet with IntelliSkin®



**RAM-GDS-DOCK-SAM62CU**  
 GDS® Tough-Dock™ + Data Sync for Samsung Galaxy Tab Active3



**RAM-HOL-GE4PU**  
 RAM® Form-Fit Powered Dock for Getac ZX10

## Recommended Mounts



**RAM-101U**  
 RAM® Double Ball Mount Drill-Down C-Size



**RAP-401-202U**  
 RAM® Tough-Claw™ Large Clamp Double Ball Mount with Round Plate



**RAM-101-B-225B2U**  
 RAM® Drill-Down Dashboard Mount with Backing Plate



**RAM-101U-D**  
 RAM® Long Double Ball Mount Drill-Down C-Size



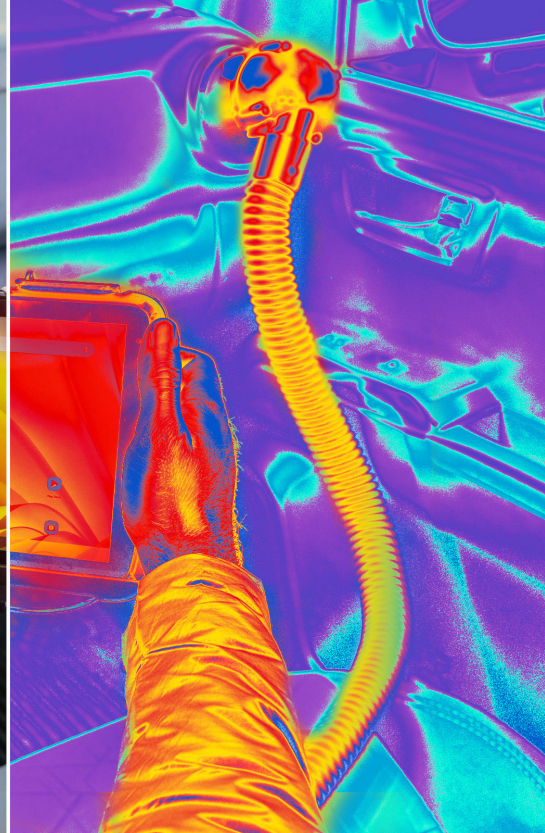

**SEEN IN THIS PHOTO:**

**RAM-HOL-ZE21PDU**

RAM® Power + Dual USB Locking Dock for Zebra ET4x 10"

**RAM-VENT1-RND-50U**

RAM® Vent-Temp™ with Back Dock Connection for Round Vents

# Accessories & Add-Ons

## New Temperature Control Products

Located at the back of your dock is an empty housing for upgrading your mounting solution. This housing can accommodate various temperature modules provided by RAM® Mounts. Easily install either the RAM® Vent-Temp™, which connects to your vehicle's A/C vents or the RAM® Temp-Right™, which provides regulated heat in extremely cold environments.

### Compatible Docks



Tab Active3 Modular and Low-Profile Docks



Zebra ET4x RAM® and GDS® Docks



All GDS® Tough-Dock™



## RAM® Vent-Temp™ Back Nozzle Attachment

Hot or cold air from your vehicle's air system enters through the RAM® Temp-Right™ nozzle, travels through flexible tube, and exits behind the docked tablet.

### RAM-VENT1-RCT-50U

RAM® Vent-Temp™ with Back Dock Connection for Rectangular Vents

### RAM-VENT1-RND-50U

RAM® Vent-Temp™ with Back Dock Connection for Round Vents

## RAM® Vent-Temp™ Front Nozzle Attachment

Hot or cold air from your vehicle's air system enters through the RAM® Temp-Right™ nozzle, travels through flexible tube, and exits in front of the docked tablet.

### RAM-VENT2-RCT-50U

RAM® Vent-Temp™ with Front Dock Connection for Rectangular Vents

### RAM-VENT2-RND-50U

RAM® Vent-Temp™ with Front Dock Connection for Round Vents

### FEATURES



Vent cover attaches directly to circular vents using zip ties

Hose attachment includes built-in magnets for easy break-away when not in-use

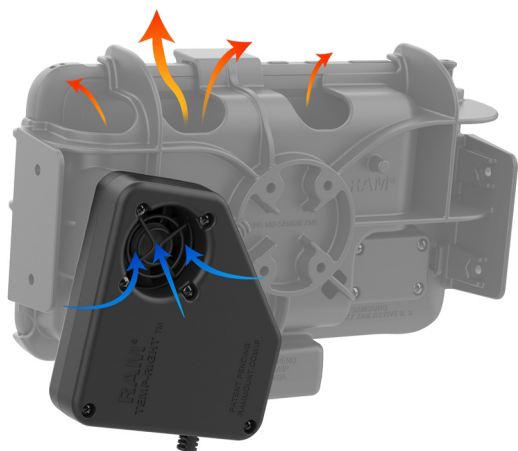

## RAM® Temp-Right™

The RAM® Temp-Right™ heater module regulates device temperatures to maintain functionality in extreme cold environments and contains integrated 11-16VDC hardware charger. Cabin air gets sucked through Temp-Right™ fan and through the module, heating the air up to the right temperature needed for tablet functionality.

### RAM-DOCK-HEATER1-BU

RAM® Temp-Right™ Dock Heating Module for GDS® Tough-Dock™

### RAM-DOCK-HEATER1-CU

RAM® Temp-Right™ Dock Heating Module for Samsung Tab Active3





**SEEN IN THIS PHOTO:**

**RAM-SKIN-SAM73**

RAM® Skin™ for Samsung Galaxy Tab Active3

**RAM-GDS-HS1U**

GDS® Hand-Stand™ Hand Strap Accessory



**Built-in LED**

Select IntelliSkin® cases have a built-in LED option for those limited light situations when you need a flashlight in a pinch.

**RAM-GDS-SKIN-SAM80-NG-LED**

IntelliSkin® with LED Light for Samsung Tab A7 Lite 8.7"

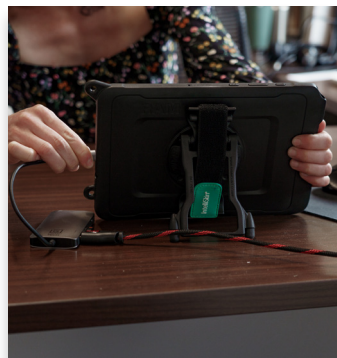

**Transfer Workstations**

The GDS® Hand-Stand™ Hand Strap with Kickstand works with all IntelliSkin® and RAM® Skin™ for an easy way to take advantage of workstation enablement such as Samsung DeX.

**RAM-GDS-HS1U**

GDS® Hand-Stand™ Hand Strap and Kickstand for Tablets

**ACCESSORIES & ADD-ONS CONTINUED**

**GDS® Ergo™**

The RAM® Skin™ and IntelliSkin® product lines are compatible with a variety of GDS® Ergo™ accessories that enable your tablet for field use. Make traveling with your tablet more comfortable and efficient by pairing your device with the GDS® Hand-Stand™—this combination hand strap and kickstand accessory allows you to take your device from the warehouse to the office and everywhere in between. Take advantage of mounting your tablet to magnetic surfaces with the GDS® Roto-Mag™ and the magnetic version of the GDS® Hand-Stand™.



**NEW**

**RAM-GDS-ROTO2U**  
GDS® Roto-Mag™  
3-in-1 Accessory

**NEW**



**RAM-GDS-ROTO2-ZE20U**  
GDS® Roto-Mag™ and Battery  
Cover for Zebra ET4x 8"

**NEW**



**RAM-GDS-ROTO2-ZE21U**  
GDS® Roto-Mag™ 3-in-1 Accessory  
for Zebra ET4x 10" Enterprise Tablet

**NEW**



**RAM-GDS-HS1U**  
GDS® Hand-Stand™ Hand  
Strap and Kickstand

**NEW**



**RAM-GDS-HS1-ZE21U**  
GDS® Hand-Stand™ for  
Zebra ET4x 10"

**RAM-GDS-HS2-ZE21U**  
GDS® Hand Strap Accessory  
for Zebra ET4x 10"



ACCESSORIES & ADD-ONS CONTINUED

# Single & 6-Port Charging Docks

The RAM® 6-Port Charging Dock was designed specifically to support up to six Samsung Galaxy Tab Active4 Pro and Tab Active Pro, Tab Active3 & 2 devices for simultaneous charging. These charging stations reduce the amount of charging cords needed to charge each device by consolidating power through one cord and provide each Samsung tablet with its own charging bay to reduce clutter.



**RAM-GDS-DOCK-D7U**  
 GDS® Desktop Dock with Power Delivery



**RAM-GDS-DOCK-D7AU**  
 GDS® Desktop Dock with Power Delivery & Peripheral Port



**RAM-GDS-DOCK-6G1PD-NGU**  
 GDS® 6-Port Power Delivery Desktop Charger for IntelliSkin® Next Gen

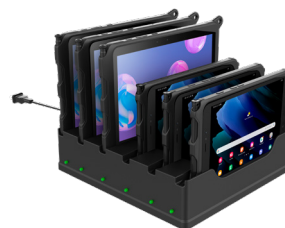

**RAM-DOCK-668PU**  
 RAM® 6-Port Desktop Charger for Samsung Galaxy Tab Active4 Pro & Tab Active3

## Additional Features

- 1 Integrated pogo-pin contacts match Samsung Tab Active pogo pads for connectivity
- 2 Removable form-fit spacers used for Tab Active3 & 2
- 3 6-Port Dock allows space for ergonomic accessories
- 4 LED lights indicate charge status



## Multi-Port for Handhelds

Multi-port charging docks are available for phones and handhelds compatible with caseless phones, IntelliSkin®, and OtterBox.

- **RAM-DOCK-6G-SAM84CPU**  
 RAM® 6-Port Charging Dock for Samsung Galaxy XCover6 Pro with RAM® Skin™

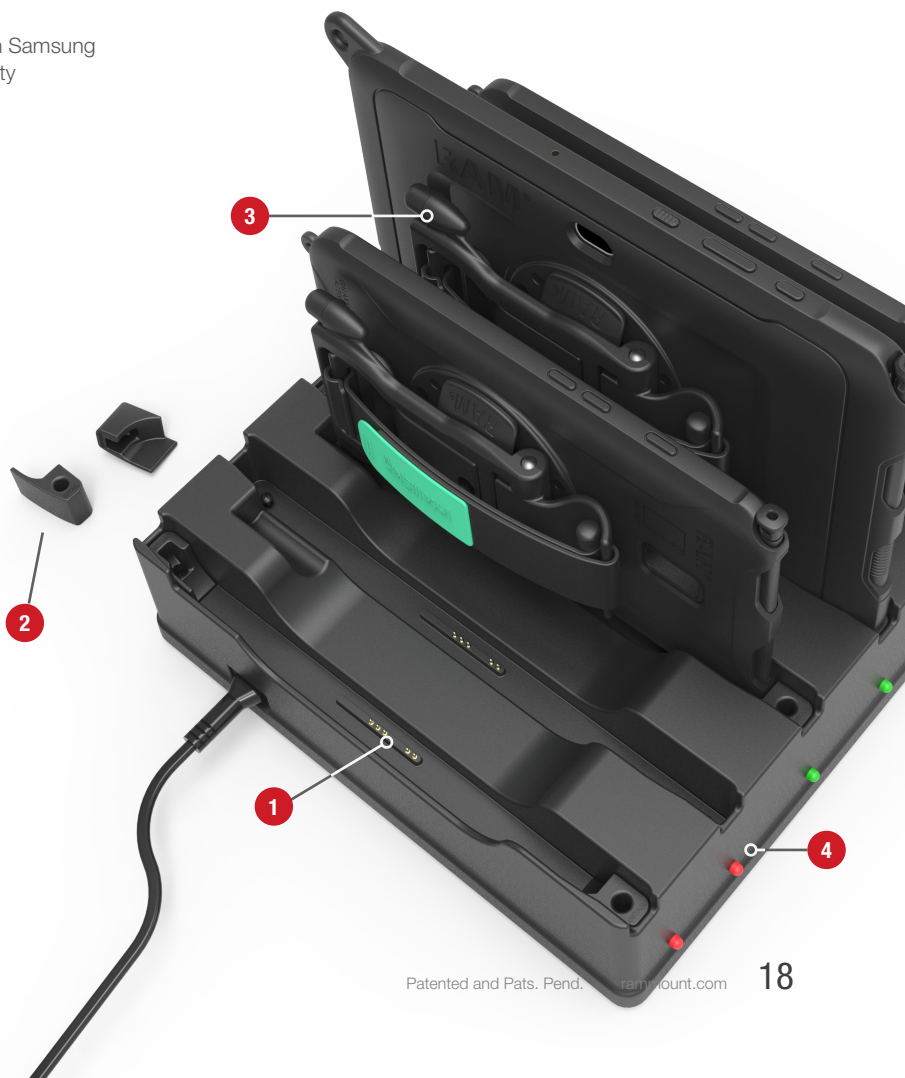





**SEEN IN THIS PHOTO:**

**RAM-GDS-CHARGE-V7CU**

RAM® Modular 10-30VDC Hardwire Charger  
with Male USB Type-C Connector



# Hardwire Chargers

## for Handhelds and Phone Docks



**RAM-GDS-CHARGE-M55-V7B1U**  
 GDS® Modular 10-30VDC Hardwire Charger with 90-Degree DC Cable



**RAM-GDS-CHARGE-M55-V8BU**  
 GDS® Modular 30-64VDC Hardwire Charger with 90-Degree DC Cable



**RAM-GDS-CHARGE-V10U**  
 GDS® 10-32VDC Input (12VDC Output) Hardwire Charger with Male DC 5.5mm

## for Tablet Docks

NEW



**RAM-GDS-CHARGE-V7CU**  
 GDS® Modular 10-30VDC Hardwire Charger with Male USB Type-C Connector



**RAM-GDS-CHARGE-USBC-V7B1U**  
 GDS® Modular 10-30VDC Hardwire Charger with USB Type-A to Type-C



**RAM-GDS-CHARGE-USBC-V8BU**  
 GDS® Modular 30-64VDC Hardwire Charger with USB Type-A to Type-C



**RAM-GDS-CHARGE-V3FC-1U**  
 GDS® Modular 10-30VDC Hardwire Charger with Male USB Type-C Connector



**RAM-GDS-CHARGE-V3FCA-1U**  
 GDS® Modular 30-64VDC Hardwire Charger with 90-Degree DC Cable



**RAM-GDS-CHARGE-V3FCA2-1U**  
 GDS® Modular 10-30VDC Hardwire Charger with 90-Degree DC Cable

## Connecting Your Charger

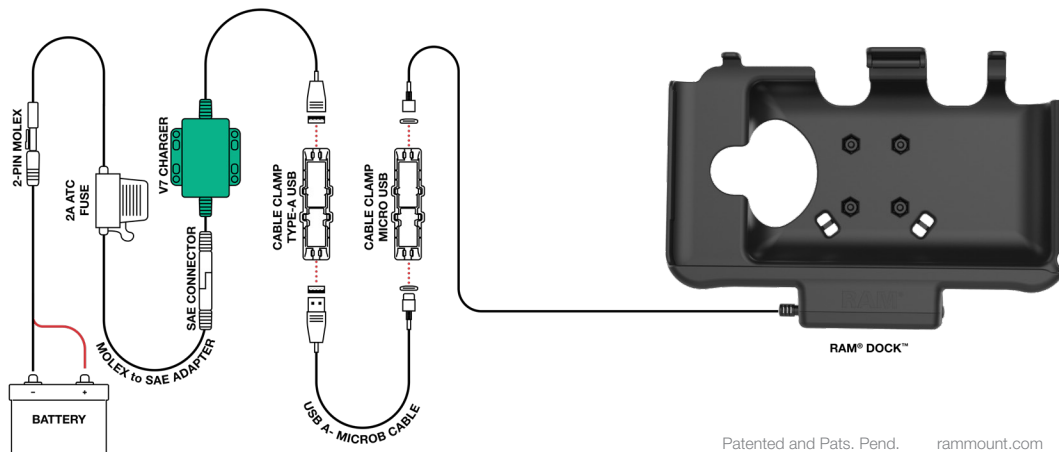



# Universal Holders

## RAM® Tab-Tite™ & Tab-Lock™

The RAM® Tab-Tite™ & Tab-Lock™ are rugged, universal tablet holders that are available in locking and non-locking options, can support tablets with or without a case, and can be mounted virtually anywhere. The spring-loaded design makes it easy to insert and remove your tablet while keeping it secure. The RAM® Tab-Tite™ & Tab-Lock™ product lines are future-proof—simply modify the holder with interchangeable top and bottom cups when upgrading your device.

## Popular Holders

Modular and case-friendly



**RAM-HOL-TABL-SAM29U**  
RAM® Tab-Lock™  
Holder for Samsung  
Tab Active3 & 2



**RAM-HOL-TABL20U**  
RAM® Tab-Lock™  
Holder for 9"-10.5"  
Tablets with Heavy  
Duty Cases

**RAM-HOL-TAB-SAM29U**  
RAM® Tab-Tite™ Holder  
for Samsung Tab Active3 & 2

**RAM-HOL-TAB20U**  
RAM® Tab-Tite™ Holder for 9"-10.5" Tablets  
with Heavy Duty Cases



**RAM-HOL-TABL4U**  
RAM® Tab-Lock™  
Spring Loaded Holder  
for 7"-8" Tablets  
with Cases

**NEW**



**RAM-HOL-TABL33U**  
RAM® Tab-Lock™  
Holder for 10.1"-10.5"  
Tablets with or  
without Case

**RAM-HOL-TAB4U**  
RAM® Tab-Tite™ Spring Loaded Holder  
for 7"-8" Tablets with Cases

**RAM-HOL-TAB33U**  
RAM® Tab-Tite™ Holder for 10.1"-10.5"  
Tablets with or without Case

## Complete Kits



**RAM-VB-195-TAB20**  
RAM® Tab-Tite™ 9-10.5"  
Tablet Mount for '15-23  
Ford F-150, F-250 + More



**RAM-101B2-TAB20U**  
RAM® Dashboard Mount with Backing Plate  
for 9"-10.5" Tablets with Cases



**RAM-B-138-TAB4-225B2U**  
RAM® Tab-Tite™ Drill-Down Mount  
with Backing Plate for Small Tablets



SEEN IN THIS PHOTO:

**RAM-HOL-TAB24U**

RAM® Tab-Tite™ Holder for 8" Tablets



**FEATURES**

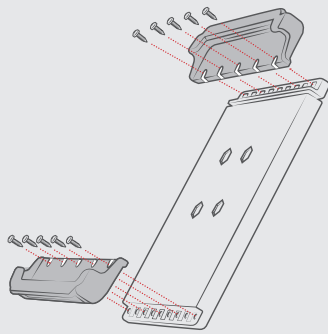

- Interchangeable cups support any tablet

Non-locking and locking options available

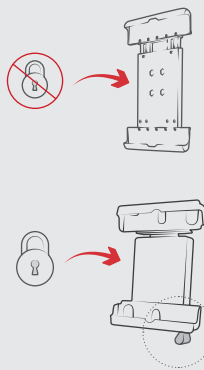

Locking mechanism for theft deterrence

Supports tablets in portrait and landscape mode

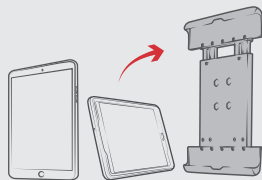

- Adjustable to secure your

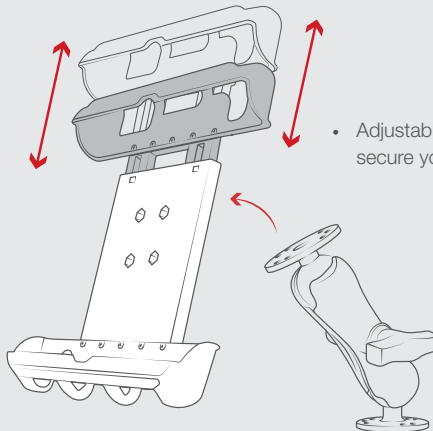

Made of high-strength composite for durability and reliability in the most demanding environments



SEEN IN THIS PHOTO:

**RAM-HOL-UN9U**

RAM® X-Grip® Holder  
for 9"-10" Tablets



**RAM-HOL-UN9U**

RAM® X-Grip® Universal Holder  
for 9"-10" Tablets



**RAM-HOL-UN11U**

RAM® X-Grip® Universal Holder  
for 12" Tablets



**RAM-HOL-UN8BCU**

RAM® X-Grip® Universal Holder  
for 7"-8" Tablets with Ball

**UNIVERSAL HOLDERS CONTINUED**

**RAM® X-Grip®**

Using a tablet for in-vehicle navigation and mobile work is on the rise. The RAM® X-Grip® for tablets holds all the benefits and design features of the standard X-Grip® with added arm support for a variety of different size tablets with or without a case. Additional grip handles provide side support for portrait or landscape orientation and are completely removable. Protect your investment with the highly rugged X-Grip® and be sure your device will stand the test of time in the harshest environments.

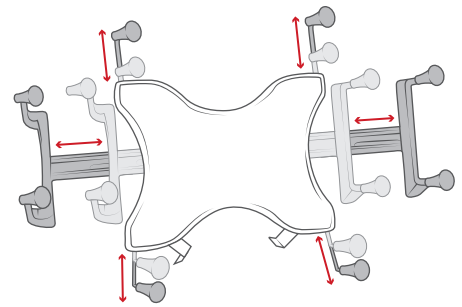

Additional grip handles for convenient insertion and removal

**FEATURES**

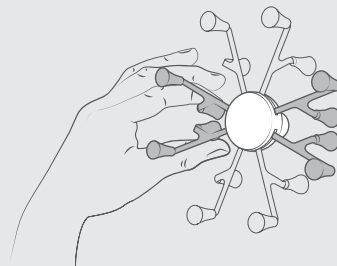

Highly adjustable to support tablets in portrait and landscape mode

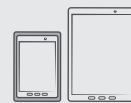

- Fits all tablets 7"-12" with or without

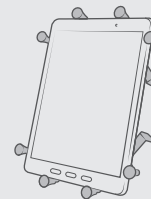

- Steel spring-loaded arms keep tablets

**SEEN IN THIS PHOTO:**

**RAP-B-299-4-UN8U**

RAM® X-Grip® for 7"-8" Tablets with  
RAM® Stubby™ Cup Holder Base



**RAP-B-299-4-UN8U**  
RAM® X-Grip® for 7"-8" Tablets  
with RAM® Stubby™ Cup Holder Base



**RAM-HOL-UN7BU**  
RAM® X-Grip® Universal Small  
Phone Holder with Ball



**RAM-HOL-UN10BU**  
RAM® X-Grip® Universal Large  
Phone Holder with Ball



**RAM-101B2-UN9U**  
RAM® X-Grip® Dashboard Mount with  
Backing Plate for 9"-10" Tablets



**RAM-VB-195-UN9**  
RAM® X-Grip® 9"-10" Tablet Mount for  
'15-23 Ford F-150, F-250 + More



**RAM-400-B-UN8U**  
RAM® X-Grip® with Tough-Claw™  
Mount for 7"-8" Tablets





rammount.com  
1.800.497.7479  
sales@rammount.com



IntelliSkin®



GDS®  
TECH™

GDS®, IntelliSkin®, GDS® Tech™, GDS® Technology™, GDS® Green™ and GDS® Compatible™ are trademarks or registered trademarks of National Products Inc. The distinctive D Shape™ of the GDS® connector is a trademark of National Products Inc.

PATENTS AND TRADEMARKS  
WWW.RAMMOUNT.COM/MP



RAM® double socket arms with their distinctive Hourglass Shape are recognized globally as a symbol of the reliability, quality, and durability of this line of products. The Hourglass Shape is a registered trademark of National Products Inc.



The distinctive RAM® "X-Grip®" product shape is a trademark of National Products Inc.



Look for the highly recognizable "Double Delta" trademark, the symbol of quality and reliability