



# RAM<sup>®</sup> MOUNTS

Powersports





# TABLE OF CONTENTS

## 04 ABOUT RAM® MOUNTS

---

## 05 HOW IT WORKS

---

## 07 RIGGING MAP FOR MOTORCYCLES

---

## 10 DEVICE HOLDERS

- 10 WIRELESS CHARGERS
  - 12 RAM® X-GRIP®
  - 14 RAM® QUICK-GRIP™
  - 16 LOW-PROFILE PHONE HOLDERS
  - 18 CAMERA ADAPTERS
  - 20 GPS FORM-FIT HOLDERS
- 

## 24 BASES

---

## 38 UTV MOUNTS

---

## 42 ATV MOUNTS

---

## 44 DIRT BIKE/DUAL SPORT MOUNTS

---

## 54 SNOWMOBILE MOUNTS

---

## 56 ACCESSORIES & MORE

- 56 ARMS
  - 60 DRINK HOLDERS
- 

## 62 THE SHAPE THAT STARTED IT ALL



# ABOUT RAM® MOUNTS

RAM® Mounts manufactures rugged and versatile mounting systems for phones, tablets, and other mobile devices that can be attached nearly anywhere. Unlike other mounts on the market, RAM® allows you to secure devices where you need them most. The unique design of RAM® mounting systems provide quick installation, adjustability, strength, vibration damping, and durability. Backed by a lifetime warranty, RAM® uses powder-coated, marine-grade aluminum with lightweight and high-strength composites, stainless steel hardware, and rubber balls.

## The RAM® Difference

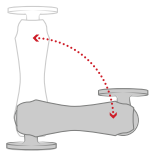

### PREMIUM DESIGN

The rubber ball and socket design of our mounting systems offers a secure hold, with near-infinite adjustability and vibration damping for the most demanding environments. With thousands of components trusted by users around the world, we've been able to design and develop mounting solutions that consumers and companies previously only dreamed were possible.

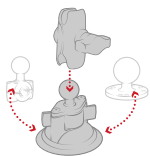

### CUSTOMIZABLE

Take your phone mount from your truck, to your boat, or mix and match components to create your ideal mount for any mounting location. Because of the modularity of the RAM® system, you can customize your solution to fit your specific needs in almost any application.

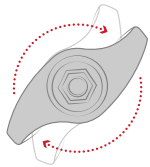

### QUALITY MATERIALS

A premium design deserves the highest quality materials available, from rubber and stainless steel to high-strength composites and marine-grade aluminum. Our facilities—including powder coating, die casting, rubber injection molding, and shock and vibration testing—help us deliver on this promise to bring you inventive mounting solutions.

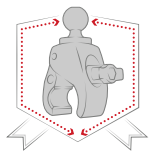

### LIFETIME WARRANTY

It's simple. Our reputation as the leader of premier mounting systems means if we build it, then we guarantee it. We're confident in the quality of our products, and with our warranty, you can be too.

## National Products Inc. (NPI)

Introduced in 1995, National Products Inc. (NPI) quickly became the leading manufacturer of rugged and versatile mounting solutions. RAM® Mounts has grown to offer approximately 5,000 modular components—the most innovative product line of its kind for nearly any application and device, including phones, tablets, GPS systems, laptops, marine electronics, printers, radios, and much more.

In addition to RAM® Mounts, NPI also provides enterprise-ready solutions. The award-winning IntelliSkin® and GDS® Technology™ product lines ruggedize a wide range of consumer phones and tablets, while the GDS® Ecosystem™ provides standardized charging, data syncing, and peripheral enablement across GDS® Docks™ and accessories in the most demanding environments.

NPI is proudly located in Seattle, Washington in the same neighborhood where the company was started.

## Partner with RAM® Mounts

Here at RAM® Mounts, we believe that unfathomable things are possible with ingenuity. With a portfolio of more than 5,000 SKUs paired with innovative engineers and in-house product experts, we have the tools and expertise needed to create solutions that you didn't know were possible. We have the ability to solve your mounting challenges quickly, efficiently, and cost effectively.

# How it Works

## DOUBLE BALL MOUNTS

Choose from a selection of holders, socket arms, and ball bases to build a custom mount for your specific needs. Additional bases may be chosen so that your mount can support multiple devices or can be transferred to alternate mounting locations.

1

### CHOOSE A HOLDER

RAM® offers a wide selection of holders for your specific device.

2

### CHOOSE AN ARM

Select an arm based on your desired length and placement.

3

### CHOOSE A BASE

Select from a variety of bases to help secure your device where you need it.

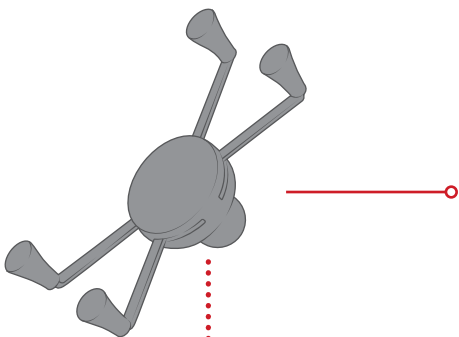
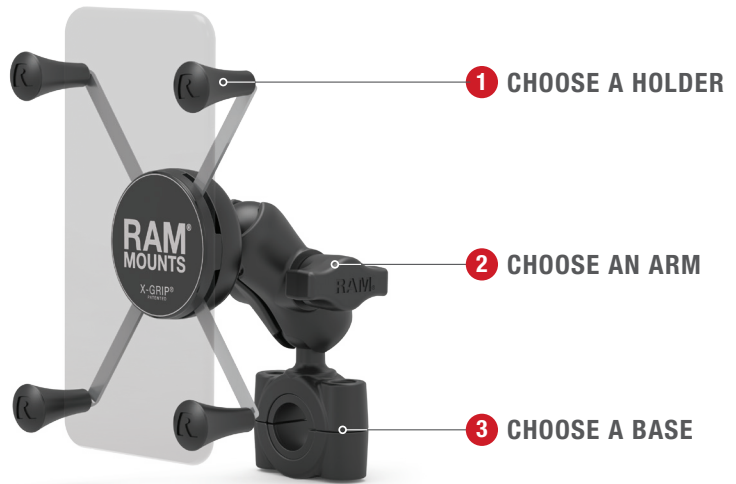

1.75" to 4.5" in width

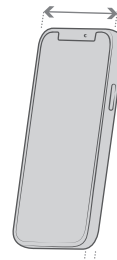

Depth Range: .875" max



Perfect fit for phones with or without a case

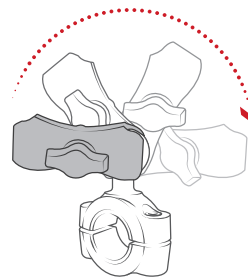
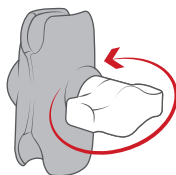
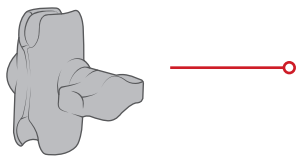

The easy-to-adjust knob allows for near-infinite adjustability for your connected device

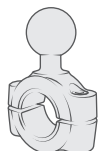

.75" - 1" diameter

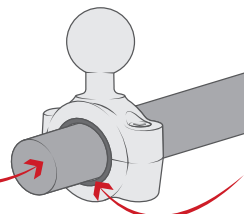

Internal bushings conform to your handlebar while protecting the surface

**1 HOLDERS**



**BEST SELLER**

**RAM-HOL-UN10BU**  
RAM® X-Grip® for Large Phones

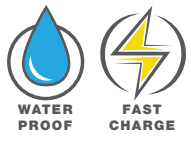

**RAM-HOL-UN12WB**  
Wireless RAM® Tough-Charge™ with X-Grip® Technology



**RAM-B-202-GA76U**  
RAM® Spine Clip Holder with Ball for Garmin Handheld Devices



**RAP-B-202U-GOP1**  
RAM® Action Camera Universal Ball Adapter



**RAM-HOL-UN8BU**  
RAM® X-Grip® Universal Holder for 7"-8" Tablets with Ball

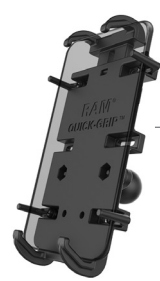

**RAM-HOL-PD4-238AU**  
RAM® Quick-Grip™ XL Holder

**2 SOCKET ARMS**



**RAM-B-201U-A**  
2.42" Short Socket Arm



**RAM-B-201U**  
3.73" Medium Socket Arm



**RAM-B-201U-C**  
6" Long Socket Arm



**RAP-B-200-12U**  
3.69" Double Socket Swivel Arm

**3 BASES**



**RAP-B-460U**  
RAM® Tough-Strap™ Handlebar Ball Base



**RAM-B-231ZU**  
RAM® Handlebar U-Bolt Base for Rails 0.5" to 1.25" in Diameter



**RAP-B-400U**  
RAM® Tough-Claw™ Small Clamp Base with Ball



**RAM-B-408-75-1U**  
.75" to 1" Diameter RAM® Torque™ Base



**RAM-B-309-7U**  
.5" to 1.25" Diameter RAM® Motorcycle Brake/Clutch Reservoir & Handlebar Ball Base



**RAM-B-342U**  
RAM® Motorcycle Fork Stem Ball Base

MORE COMPONENTS AVAILABLE AT  
[rammount.com/components](http://rammount.com/components)

# RIGGING MAP for Motorcycles



**1** **RAM-B-408-112-15U**  
RAM® Torque™ Large  
Rail Base



**2** **RAM-B-309-7U**  
RAM® Motorcycle  
Brake/Clutch Reservoir  
& Handlebar Ball Base



**3** **RAP-B-379-HA1U**  
RAM® Tough-Ball™  
Mirror Base for Harley-  
Davidson Motorcycles



**4** **RAM-B-231ZU**  
RAM® Handlebar U-Bolt  
Base for Rails 0.5" to  
1.25" in Diameter



**1** **RAM-B-349U**  
RAM® Ball Adapter with M10 X 1.25  
Threaded Post



**2** **RAP-B-400U**  
RAM® Tough-Claw™ Small Clamp  
Base with Ball



**3** **RAM-B-367U**  
RAM® Motorcycle Handlebar Clamp  
Base with M8 Bolt





**1** **RAM-B-408-75-1U**  
 RAM® Torque™ Medium Rail Base



**2** **RAM-B-252U**  
 RAM® 11mm Bolt Head Adapter Ball Base



**3** **RAM-B-345U**  
 RAM® Centered Reservoir Cover Ball Base



**1** **RAM-B-309-7U**  
 RAM® Motorcycle Brake/Clutch Reservoir & Handlebar Ball Base



**2** **RAM-B-410U**  
 RAM® Small Gas Tank Ball Base for Motorcycles



**3** **RAM-B-342U**  
 RAM® Motorcycle Fork Stem Ball Base



SEEN IN THIS PHOTO:

**RAM-B-149Z-A-UN12W-V7M**

RAM® Tough-Charge™ Waterproof Wireless Charging Motorcycle Mount

**FEATURES**

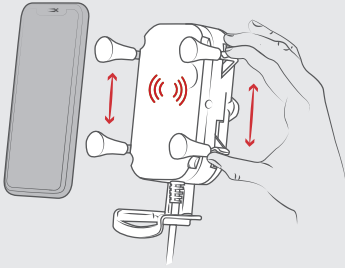

Featuring RAM® X-Grip® Technology, this spring-loaded holder has an 'X' design that expands and contracts to secure nearly any phone



Includes ON/OFF switch when wireless charger is not in use

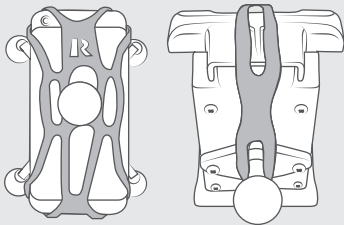

Includes safety tether for extra peace of mind

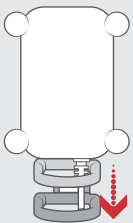

RAM® Tough-Charge™ includes adjustable support leg



**FAST CHARGE**



**WATER PROOF**

Qi Compatible charging up to 10W, sealed and safe for open cockpit environments

# Device Holders

## PHONE

### Wireless Charging

The RAM® X-Grip® and RAM® Quick-Grip™ product lines grew with the world's first patented, universal, waterproof wireless charging holders for smartphones. Designed with spring-loaded technology, utilize the best parts of both the RAM® X-Grip® and RAM® Quick-Grip™ phone holders while pairing any smartphone with wireless charging capabilities. For added security and peace of mind, a safety tether is included and recommended for outdoor applications. Available in a variety of mounting kits, keep your phone charged wherever you're going.

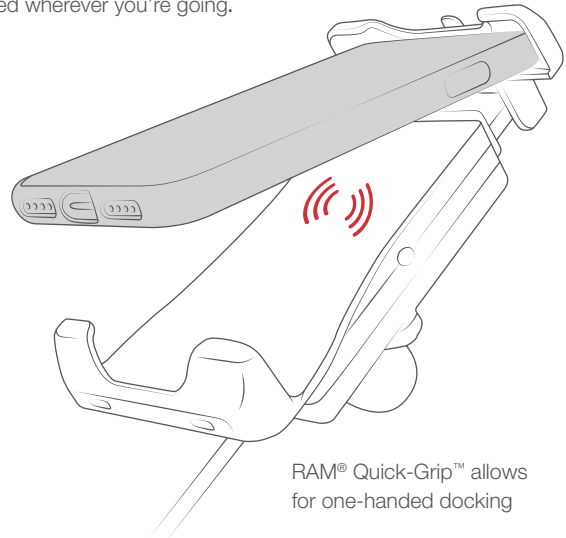

RAM® Quick-Grip™ allows for one-handed docking

**BEST SELLER**

**RAM-HOL-UN14WB**  
RAM® Quick-Grip™ Waterproof Wireless Charging Holder







**BEST SELLER**

**RAM-HOL-UN12WB**  
RAM® Tough-Charge™ with X-Grip® Tech Waterproof Wireless Charging Holder

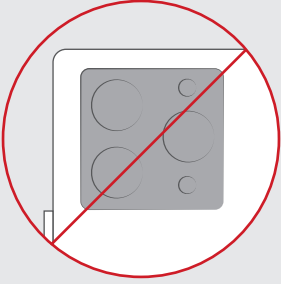
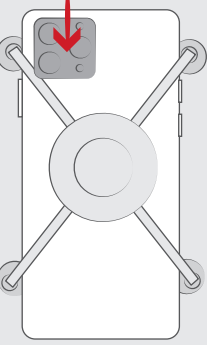

# HOW TO CHOOSE the Right Phone Holder

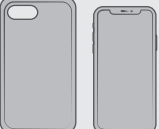
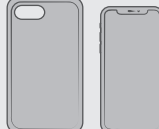
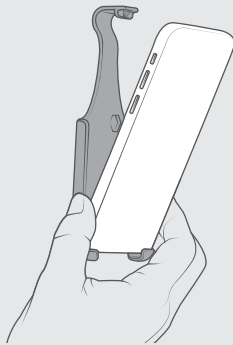
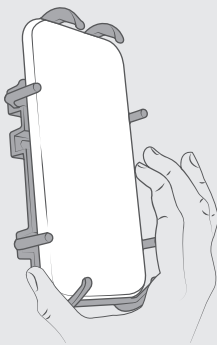
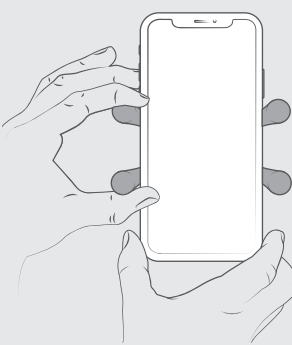
FORM-FIT	RAM® QUICK-GRIP®	RAM® X-GRIP®
		
<p>Camera Exposed</p>	<p>Camera Blocked Depending on Model</p>	<p>Camera Exposed *Without Tether</p>
		
<p>Price</p> <p>\$</p>	<p>Price</p> <p>\$</p>	<p>Price</p> <p>\$\$\$</p>
<p>Without Case</p> 	<p>With or Without Case</p> 	<p>With or Without Case</p> 
<p>One-Handed Docking</p>	<p>One-Handed Docking</p>	<p>Two-Handed Docking</p>
		



**FEATURES**

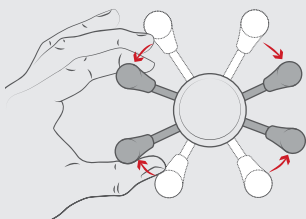

The spring-loaded arms expand and contract to provide a perfect fit for your phone with or without a case.

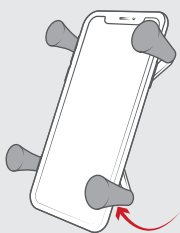

Spring-loaded 'X' design with rubber caps sports great holding power without hiding your phone

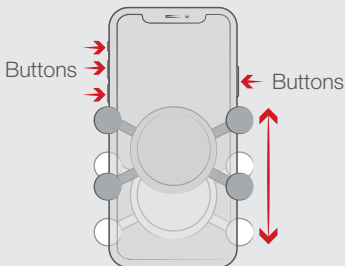

Adjust the RAM® X-Grip® move up and down to expose and access buttons

**DEVICE HOLDERS CONTINUED**

**RAM® X-GRIP®**

The RAM® X-Grip® is the most durable universal phone holder on the market. The spring-loaded arms expand and contract to provide a perfect fit for your phone with or without a case. Available for phones of all sizes, the RAM® X-Grip® secures your device while keeping it completely functional and accessible. No matter what mounting base you pair with the RAM® X-Grip®, the RAM® ball and socket technology allows for near-infinite adjustability and extends the life of your phone with vibration damping capabilities.



**RAM-HOL-UN7BU**  
RAM® X-Grip® Universal Phone Holder with Ball

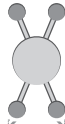

Minimum Width:  
1.875"

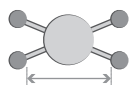

Maximum Width:  
3.25"

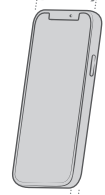

1.875" - 3.25"  
.875" max



**RAM-HOL-UN10BU**  
RAM® X-Grip® Large Phone Holder with Ball



Minimum Width:  
1.75"

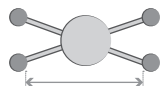

Maximum Width:  
4.5"



1.75" - 4.5"  
.875" max

**BEST SELLER**

SEEN IN THIS PHOTO:

**RAM-B-149Z-A-PD4U**  
RAM® Quick-Grip™ XL Phone Mount with  
Handlebar U-Bolt Base



**FEATURES**

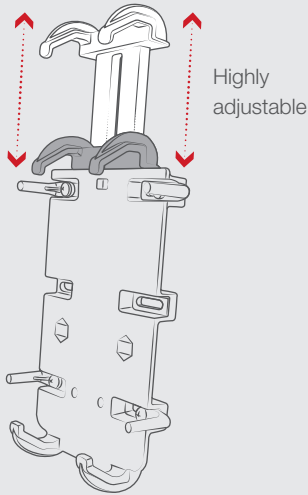

Highly adjustable

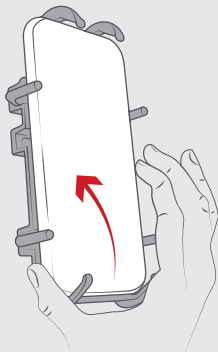

One-handed docking and removal

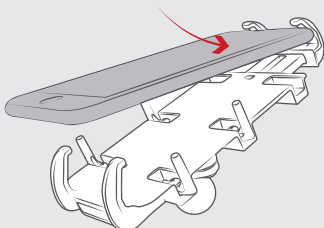

Spring-loaded top grip keeps device in place

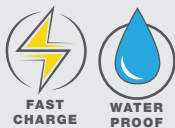

The RAM® Quick-Grip™ Wireless is a patented, universal, waterproof wireless charging phone holder

**DEVICE HOLDERS CONTINUED**

**RAM® QUICK-GRIP™**

Capable of holding a broad range of electronics, the RAM® Quick-Grip™ provides a secure fit for your phone with or without a case. Take advantage of efficient one-handed docking and removal of your device no matter if your phone is in portrait or landscap mode. The adjustable side support arms add extra security and shift to fit the width of your device perfectly. Available for standard size phones and larger models.

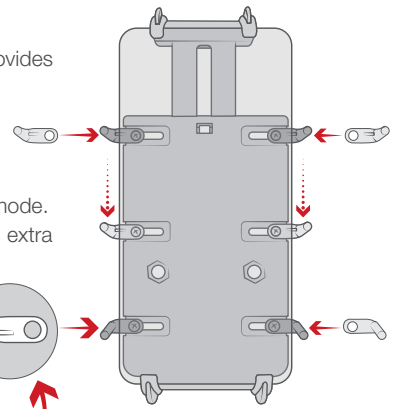

Adjustable side fingers for wider devices can move to expose any buttons



**RAM-HOL-PD3-238AU**  
RAM® Quick-Grip™

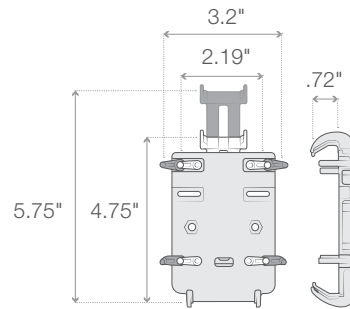

**BEST SELLER** **RAM-HOL-PD4-238AU**  
RAM® Quick-Grip™ XL

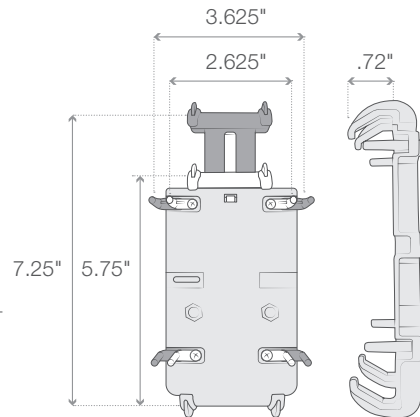

**RAM-HOL-UN14WB**  
RAM® Quick-Grip™ Wireless Charger

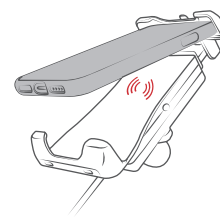

Features spring-loaded RAM® Quick-Grip™ design and 10W maximum output

SEEN IN THIS PHOTO:

**RAM-HOL-PD4-400-1U**

RAM® Quick-Grip™ XL Phone Mount  
with Low-Profile Tough-Claw™





**FEATURES**



Perfect fit for phones with or without a case

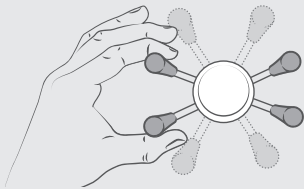

The spring-loaded arms expand and contract to provide a perfect fit for your phone

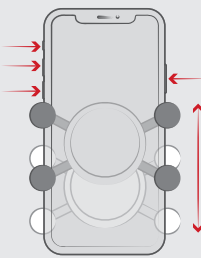

Rubber caps provide great holding power without hiding your phone or any buttons

Easily positions the RAM® X-Grip® between portrait and landscape mode

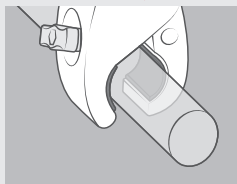
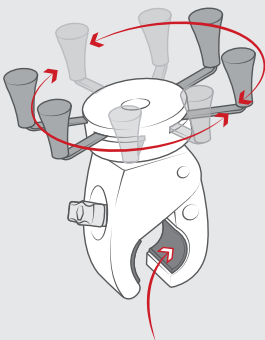

Rubber pads provide stable gripping and protection of mounting surface

**DEVICE HOLDERS CONTINUED**

**RAM® TOUGH-CLAW™ Low-Profile**

Combining the RAM® Quick-Grip™ with the RAM® Tough-Claw™ makes the ideal low-profile phone mount for all types of handlebars and rails. For those who don't need too much articulation from any of RAM®'s socket arm configurations, this mounting solution is easy and straightforward, allowing you to quickly install or remove your device from its mounting surface.



**RAM-HOL-PD4-400-1U**  
RAM® Quick-Grip™ XL Phone Mount with Low-Profile Tough-Claw™  
Clamp Range: .625" - 1.14" diameter

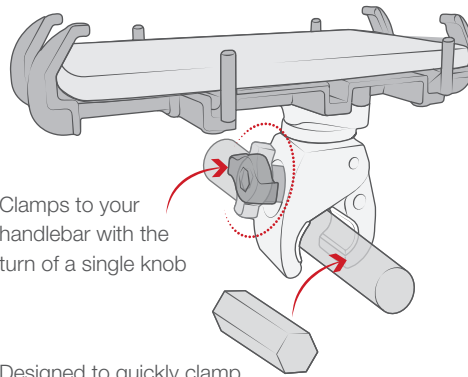

Clamps to your handlebar with the turn of a single knob

Designed to quickly clamp to round, square, and odd-shaped rails and bars

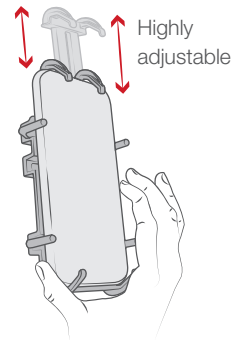

Highly adjustable  
One-handed docking and removal

**BEST SELLER**



**RAM-HOL-UN7-400-2U**  
RAM® X-Grip® Phone Mount with Low-Profile RAM® Tough-Claw™  
Clamp Range: .625" - 1.14" diameter



**RAM-HOL-UN10-400-2U**  
RAM® X-Grip® Large Phone Mount with Low-Profile RAM® Tough-Claw™  
Clamp Range: .625" - 1.14" diameter



**RAM-HOL-UN7-404-2U**  
RAM® X-Grip® Phone Mount with Low-Profile RAM® Tough-Claw™  
Clamp Range: 1" - 1.6" diameter



**RAM-HOL-UN10-404-2U**  
RAM® X-Grip® Large Phone Mount with Low-Profile RAM® Tough-Claw™  
Clamp Range: 1" - 1.6" diameter

SEEN IN THIS PHOTO:

**RAP-B-GOP2-A-GOP1U**

RAM® Ball Adapter for GoPro®  
Bases with Universal Action  
Camera Adapter

**DID YOU KNOW**

The RAM® Mounts GoPro® Adapter adds extra vibration damping to pair with the camera's image stabilization providing even smoother video.



**FEATURES**

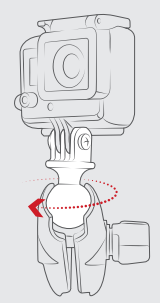
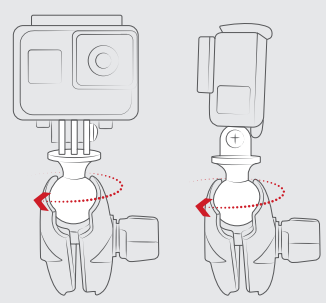

Adjust the position of your camera with the turn of a single knob

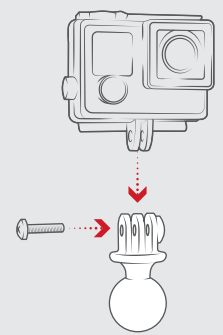

Supports all cameras with a 1/4"-20 adapter and action camera hinge adapter

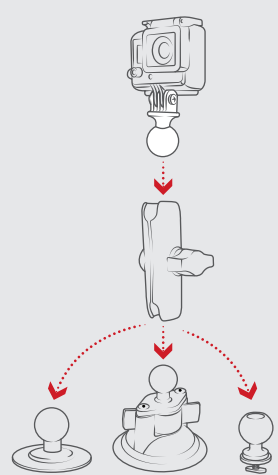

Modular components allows users to mount their camera anywhere

**DEVICE HOLDERS CONTINUED**

**CAMERA ADAPTERS**

Capture the best photos and video possible with the help of RAM® Mounts camera ball adapters, allowing for the perfect angle and a secure hold. Constructed with the highest quality materials, the RAM® ball design dampens shock and vibration to help the cameras image stabilization for a smooth video. The GoPro® base adapter is specifically designed for GoPro® action cameras and easily replaces the factory mount by combining it with a RAM® Mounts socket arm for adjustable 360 degree rotation of your camera with no hassle.

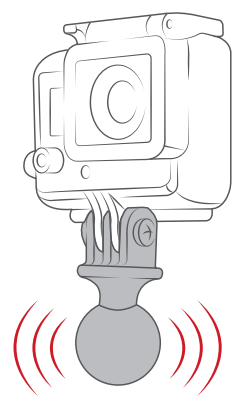

Rubber ball dampens shock and vibration



**RAM-B-202U-GOP1**  
RAM® Action Camera Universal Ball Adapter



**RAM-B-379U-252025**  
RAM® Tough-Ball™ with 1/4"-20 x .25" Threaded Stud



**RAM-B-GOP2-A-GOP1U**  
RAM® Ball Adapter for GoPro® Bases with Universal Action Camera Adapter



**RAM-B-202-GOP1-354-TRA1U**  
RAM® Track Ball™ Universal Action Camera Mount



**BEST SELLER**

**RAM-B-166-A-GOP1U**  
RAM® Twist-Lock™ Suction Cup Mount with Universal Action Camera Adapter



**RAM-B-400-A-GOP1U**  
RAM® Tough-Claw™ Mount with Universal Action Camera Adapter

**SEEN IN THIS PHOTO:**

**RAM-HOL-SP05U**

RAM® EZ-Roll'r™ Cradle for SPOT X™

**RAP-B-400-201-AU**

RAM® Tough-Claw™ Small Clamp Base with Double Socket Arm

**RAM-B-238U**

RAM® Diamond Ball Base



**SEEN IN THIS PHOTO:**

**RAM-HOL-GA75LU**

RAM® EZ-Roll'r™ Locking Cradle for Garmin Fleet 770, Overlander + More

**RAM-B-349U**

RAM® Ball Adapter with M10 X 1.25 Threaded Post

**RAM-B-103-A-238U**

RAM® Double Socket Arm with Diamond Plate



DEVICE HOLDERS CONTINUED

# GPS Form-Fit Holders

The form-fit and EZ-Roll'r™ designs carry over to GPS devices, each one capable of transferring between your vehicles or clip on your backpack or belt—allowing you to navigate safely and hands-free. Widescreen GPS devices can also take advantage of the locking holders that provide extra protection and have extra space in the back for the Garmin power accessory.

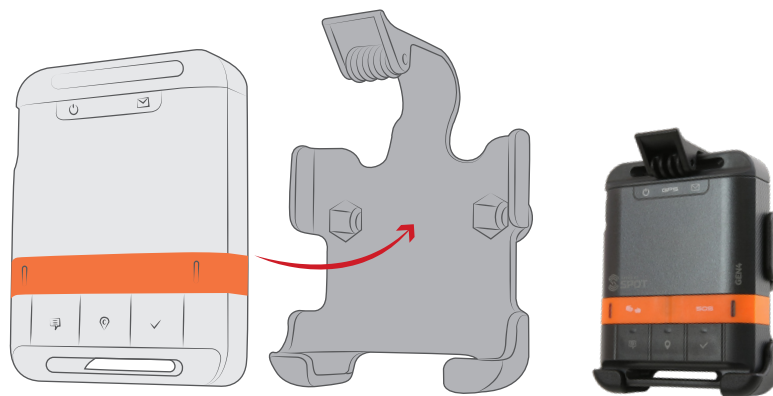

**RAM-HOL-SP06U**  
RAM® EZ-Roll'r™ Cradle for SPOT Gen4



**RAM-HOL-SP05U**  
RAM® EZ-Roll'r™ Cradle for SPOT X™



**RAM-HOL-GA31U**  
RAM® Form-Fit Cradle for Garmin Approach G5 & Oregon Series



**RAM-HOL-GA46U**  
RAM® Form-Fit Cradle for Garmin Montana 600, 650, 650T, 680 & 680T

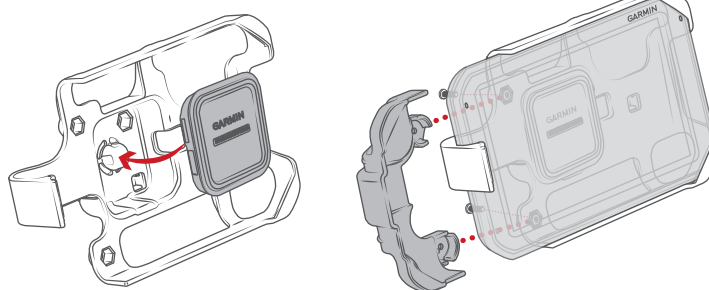

**RAM-HOL-GA75LU**  
RAM® EZ-Roll'r™ Locking Cradle for Garmin Fleet 770, Overlander + More

## FEATURES

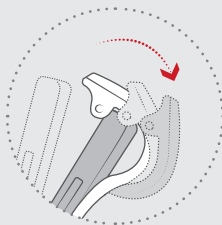

Patented RAM® EZ-Roll'r™ design protects devices and provides easy insertion and removal of your GPS

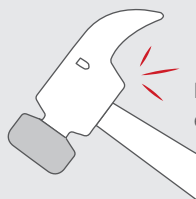

High strength materials ensure product longevity

SEEN IN THIS PHOTO:

**RAM-B-202-GA76U**

RAM® Spine Clip Holder with Ball for Garmin Handheld Devices

**RAM-B-349U**

RAM® Ball Adapter with M10 X 1.25 Threaded Post

**RAM-B-201U-A**

RAM® Double Socket Arm

**DID YOU KNOW**

The RAM® Spine Clip Adapter for Garmin devices is compatible with all Garmin devices with the spine adapter on the back—even the Garmin inReach Mini!



DEVICE HOLDERS CONTINUED

# GPS Form-Fit Holders

For an easy and secure way to mount your Garmin devices, take advantage of the integrated spine adapter by mounting to the RAM® Spine Clip Holder. Simply slide your Garmin handheld device on to the Spine Clip Holder and click it into place for an ultra-secure mounting solution. Compatible with a wide range of Garmin devices, mounting to a motorcycle, vehicle, or right onto your person has never been easier. Attach any RAM® B size double socket arm to unlock a wide range of components for just about any mounting location.



**RAM-B-202-GA76U**  
RAM® Spine Clip Holder with Ball for Garmin Handheld Devices

**BEST SELLER**

**RAM-B-166-GA76U**  
RAM® Suction Cup Garmin Spine Clip Holder

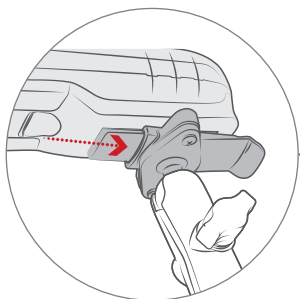

**RAM-B-138-GA76U**  
RAM® Drill-Down Mount with Garmin Spine Clip Holder



**RAM-B-400-GA76U**  
RAM® Tough-Claw™ Small Clamp Mount with Garmin Spine Clip Holder



**RAM-B-149Z-A-GA76U**  
RAM® Spine Clip Garmin Mount with Handlebar U-Bolt Base



**RAM-B-202-GA76-TRA1U**  
RAM® Track Ball™ Double Ball Mount with Garmin Spine Clip Holder

## FEATURES



ON

**RAM-B-166-GA76U**  
Patented RAM® Twist-Lock™ suction cup design

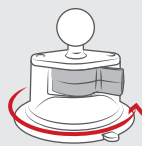

OFF



**RAM-B-202-GA76-TRA1U**  
Features a rubber friction washer and a stainless steel T-bolt; simply insert into your track and twist the ball clockwise to tighten

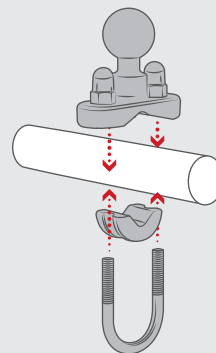

**RAM-B-149Z-A-GA76U**  
Zinc-coated metal U-Bolt base with 1" rubber ball is designed to sit at right angles to mounting rail; includes black cover caps for exposed ends of the U-Bolt

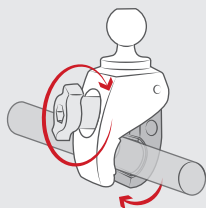

**RAM-B-400-GA76U**  
Toolless installation for convenient installation, transfer, and removal of your mounting system



**RAM-B-138-GA76U**  
2.5" round plate that connects to RAM® device holders containing the universal AMPS hole pattern



SEEN IN THIS PHOTO:

**RAM-B-149Z-GOP1U**  
U-Bolt Handlebar Mount with Universal  
Action Camera Adapter



SEEN IN THIS PHOTO:

**RAM-B-149Z-A-PD4U**  
RAM® Quick-Grip™ XL Phone Mount with  
Handlebar U-Bolt Base



**BEST  
SELLER**

**RAM-B-231ZU**  
.5" to 1.25" Diameter  
Handlebar U-Bolt Base



**RAM-B-231CHU**  
.5" to 1" Diameter Handlebar  
U-Bolt Base in Chrome



**RAM-B-231U**  
.5" to 1" Diameter  
Handlebar U-Bolt Base

## Bases

### U-Bolt Handlebar Base

This base has a 1" B size ball designed to sit at right angles on the mounting rail. The zinc-coated and stainless steel U-Bolts accommodate rails from .5" to 1.25" in diameter. Black caps are included to cover the exposed ends of the U-Bolt and a composite adapter can narrow the minimum diameter of the rail to .5".

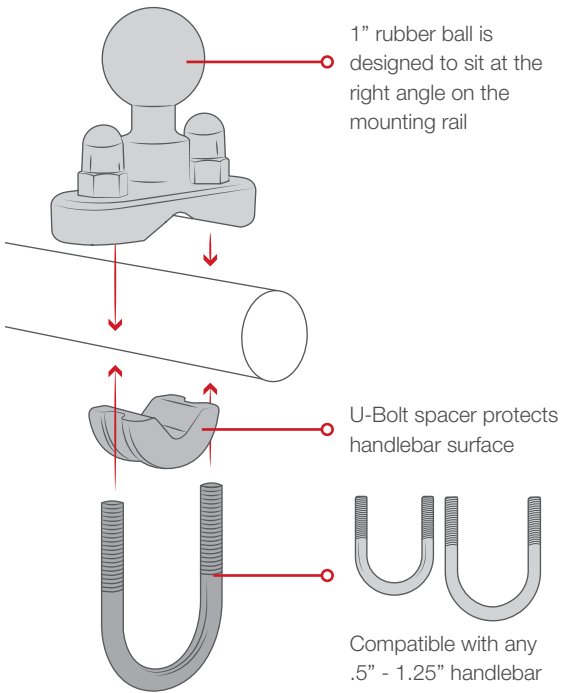

### FEATURES

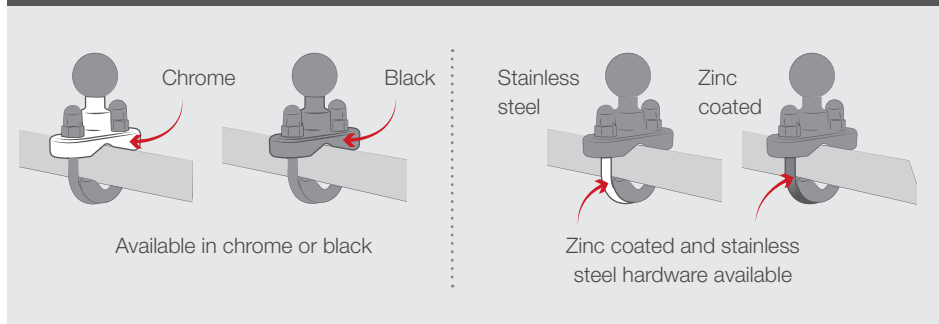

SEEN IN THIS PHOTO:

---

**RAM-HOL-UN7-400U**

RAM® X-Grip® Phone Mount with RAM® Snap-Link™ Tough-Claw™





**RAP-B-401U**  
 1" - 2.25" Diameter

**BASES CONTINUED**

**RAM® Tough-Claw™**

The RAM® Tough-Claw™ is the perfect mounting base for quick installation and removal on round, square, and odd-shaped rails and bars—such as handlebars or roll cages. The RAM® Tough-Claw™ can be clamped on rails from .625" to 2.25" in diameter, making this an ideal solution for mounting action cameras, phones, and much more.

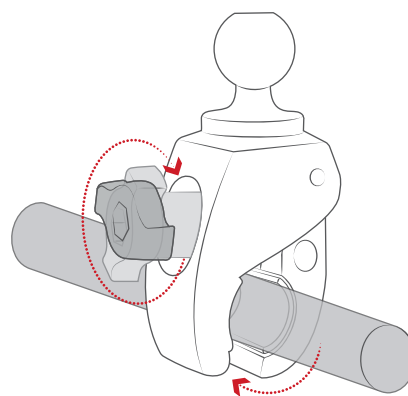

Toolless installation for convenient installation, transfer and remove base with the turn of a single knob



**RAP-B-404U**  
 1" - 1.875" Diameter

**FEATURES**

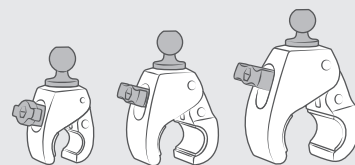
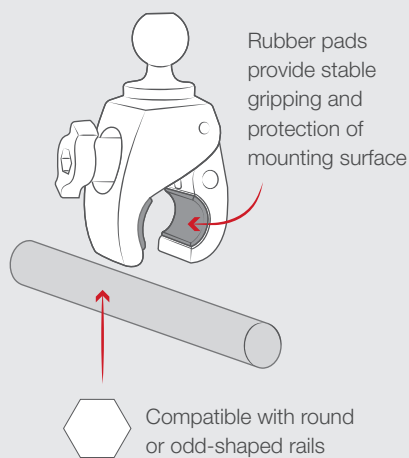

Available in three sizes to accommodate all handlebars and roll bars



Made of high-strength composites for durability and reliability in the most demanding environments



**BEST  
 SELLER**

**RAP-B-400U**  
 .625" - 1.5" Diameter



**SEEN IN THIS PHOTO:**

**RAM-B-408-37-62-A-UN7U**  
 RAM® X-Grip® Phone Mount with RAM® Torque™ Small Rail Base



**SEEN IN THIS PHOTO:**

**RAM-B-408-75-1-UN7U**  
 RAM® X-Grip® Phone Mount with RAM® Torque™ Medium Rail Base

**BASES CONTINUED**

**RAM® Torque™**

RAM® Torque™ bases fit a variety of rail and bar sizes for secure placement of your device. Sizing inserts create a tight hold while protecting the bar and are available with a 1" (B size) or 1.5" (C size) ball that attaches to a RAM® arm. Mount your GPS unit, camera, phone, or tablet to handlebars, roll cages or even mirror posts.



**RAM-B-415-15-2U**  
 RAM® Torque™ Rail Base  
 1.5" - 2" Diameter



**RAM-B-408-112-15U**  
 RAM® Torque™ Rail Base  
 1.125" - 1.5" Diameter



**RAM-B-408-75-1U**  
 RAM® Torque™ Rail Base  
 .75" - 1" Diameter



**RAM-B-408-37-62U**  
 RAM® Torque™ Rail Base  
 .375" - .625" Diameter

Internal bushings conform to your handlebar while protecting the surface

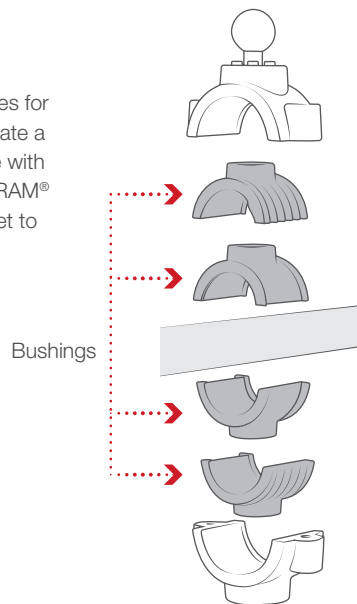
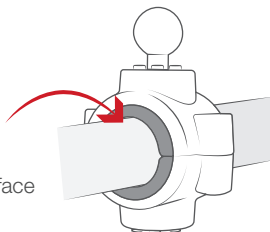

**FEATURES**

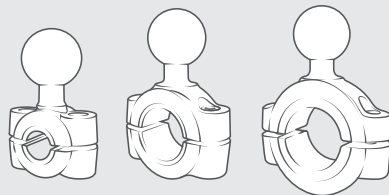

Various sizes to support rails from .375" to 2" in diameter



Made of high-strength marine-grade aluminum



Included rubber strip offers additional friction



**SEEN IN THIS PHOTO:**

**RAM-B-342**  
Fork Stem Base

**RAM-B-201U-A**  
Short Double Socket Arm

**RAP-B-202U-GOP1**  
Universal Action Camera Adapter

INTRO

RIGGING MAP

DEVICE HOLDERS

BASES

UTV MOUNTS

ATV MOUNTS

DIRT BIKES/DUAL SPORT MOUNTS

SNOWMOBILE MOUNTS

ACCESSORIES & MORE

**FEATURES**

Fits fork stem holes from 12mm - 38mm (.5" - 1.49") in diameter

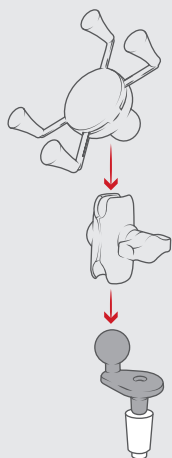
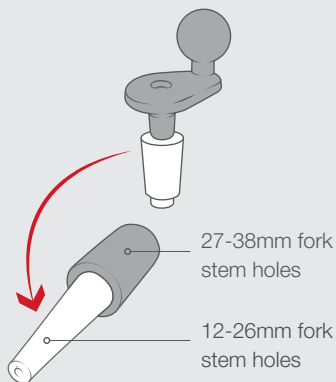

Included RAM® rubber ball allows for connection to any B size RAM® double socket arm; ball and socket technology allows for near-infinite adjustability

**BASES CONTINUED**

**Fork Stem**

The fork stem base is designed to fit and expand into the cylindrical bore wall of fork stems and will work with stems that measure 12 to 38mm (.5" to 1.49") in diameter. The base is made of powder-coated, marine-grade aluminum and includes a 1" (B size) ball.

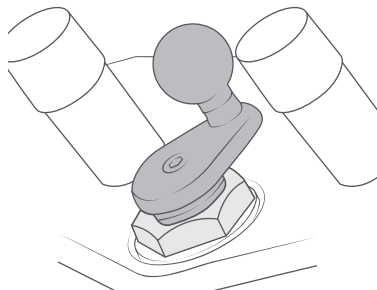
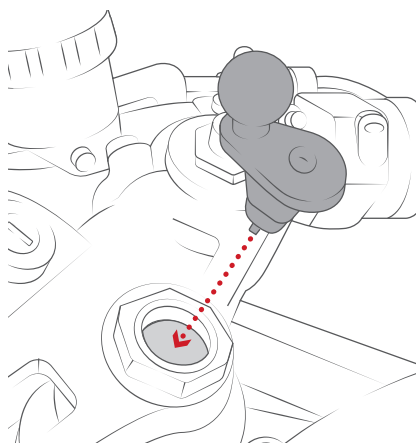

Centered, low-profile base mounts your device in the ideal position



**BEST SELLER**

**RAM-B-342U**  
RAM® Motorcycle Fork Stem Ball Base

**SEEN IN THIS PHOTO:**

**RAM-B-174-UN7U**

RAM® X-Grip® Phone Mount with  
Motorcycle Brake/Clutch Reservoir Base



**RAM-B-309-6U**

RAM® Motorcycle Brake/Clutch Reservoir  
Double Ball Base

**BASES CONTINUED**

**Brake/Clutch Reservoir  
Base**

This combination handlebar and brake/clutch reservoir base provides the ultimate flexibility for mounting your device to your motorcycle. The kit contains standard and metric threaded stainless bolts as well as zinc-coated metal U-Bolts accommodating rails from .5" to 1.25" in diameter.



**RAM-B-309-1CHU**

RAM® Chrome Motorcycle  
Brake/Clutch Reservoir  
Ball Base



**BEST  
SELLER**

**RAM-B-309-7U**

RAM® Motorcycle Brake/Clutch Reservoir  
& Handlebar Ball Base

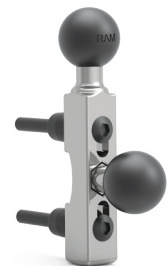

**RAM-B-309-2CHU**

RAM® Chrome Motorcycle Brake/Clutch  
Reservoir Double Ball Base

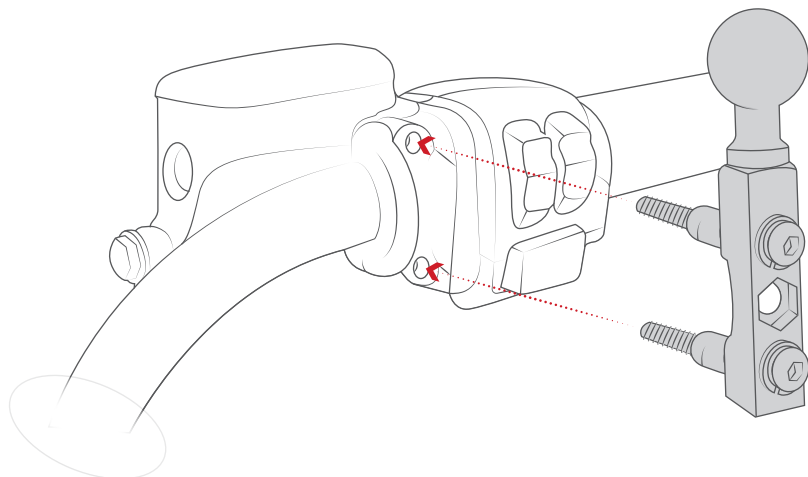



**SEEN IN THIS PHOTO:**

- RAM-B-346U**  
RAM® Offset Reservoir Cover Ball Base
- RAM-B-103U**  
RAM® Double Socket Arm with Round Plate
- RAP-300-1U**  
RAM® Power Plate™ III Universal Magnetic Holder

**BASES CONTINUED**

## Reservoir Cover Base

These bases fit over your existing brake/clutch reservoir cover with either a 1" offset ball or a 1" center ball. The plate dimensions for the center ball base measure 2.87" x 1.82", compared to 4" x 1.82" for the offset ball base.

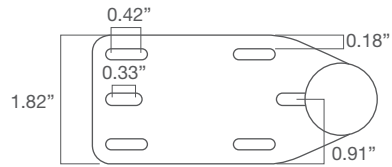
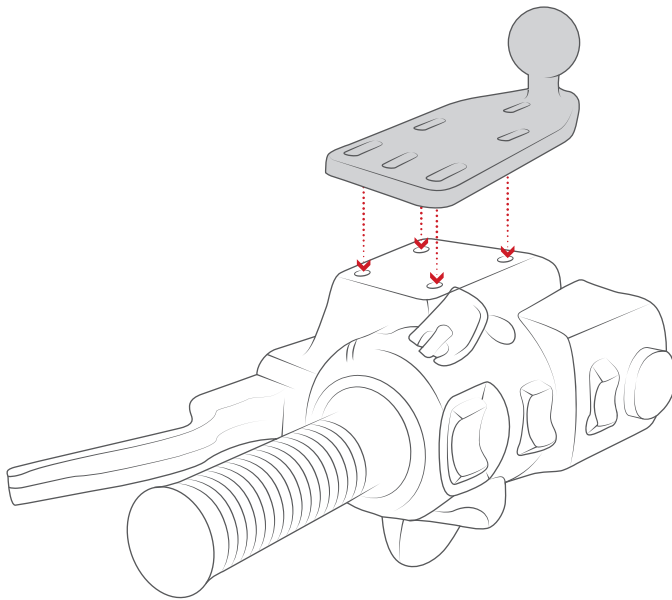

**RAM-B-346U**  
RAM® Offset Reservoir Cover Ball Base

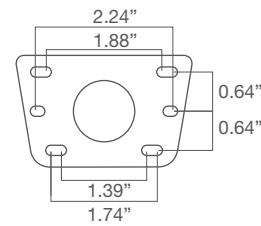

**RAM-B-345U**  
RAM® Centered Reservoir Cover Ball Base



**SEEN IN THIS PHOTO:**

- RAM-B-367U**  
Handlebar Clamp Base
- RAM-B-201U**  
RAM® Double Socket Arm
- RAM-B-202-GA76U**  
RAM® Spine Clip Holder  
with Ball for Garmin  
Handheld Devices



**BEST  
SELLER**

**RAM-B-367U**

RAM® Motorcycle Handlebar Clamp Base with M8 Bolts

**BASES CONTINUED**

**Handlebar Clamp Base**

This 1" rubber ball base will replace an M8 by 25mm, 30mm, or 35mm handlebar bolt. To determine compatibility, measure the bolt length and add 30mm to the length. Screw the ball base onto the handlebar top clamp using one of three included 1.25mm thread pitch bolts: M8 x 55mm, M8 x 60mm, and M8 x 65mm.

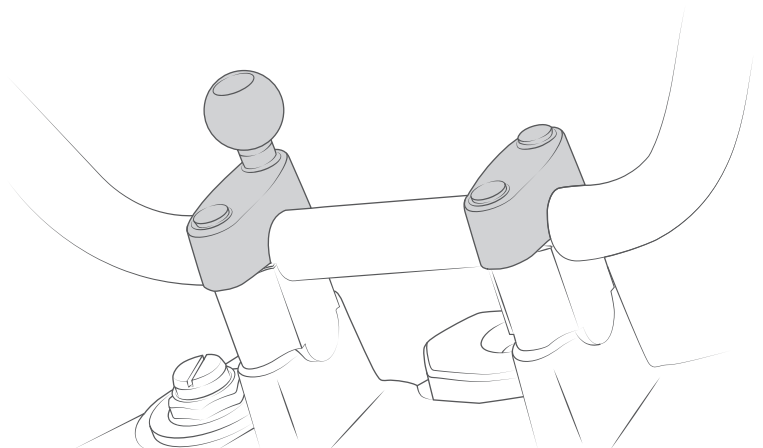



**SEEN IN THIS PHOTO:**

**RAM-B-252U**

Bolt Head Flat Base

**RAM-B-201U-A**

Short Double Socket Arm

**RAP-B-202U-GOP1**

Universal Action  
 Camera Adapter



**BASES CONTINUED**

**Bolt Head Adapter Bases**

This versatile flat base, with a bolt-down area of 2.25" x .875" x .2", includes a 1" diameter rubber ball and an 11mm hole. The angled base version also includes a 1" diameter rubber ball and a 9mm hole and a bolt-down area of 1.125" x .75" x .2". Both bolt head adapter bases are often attached to the mirror frame and fit well on exposed bolts.

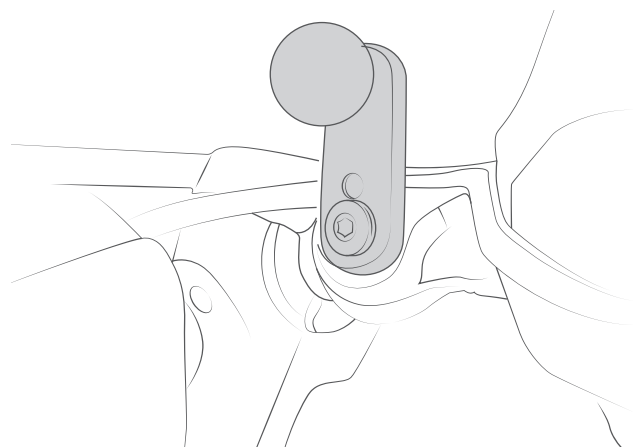

**RAM-B-252U**  
 2.25" x .875" Plate 11mm Hole



**RAM-B-272U**  
 1.125" x .75" Plate 9mm Hole



SEEN IN THIS PHOTO:

**RAM-B-410-A-UN10BU**  
 Small Gas Tank Mount with  
 RAM® X-Grip® Phone Holder

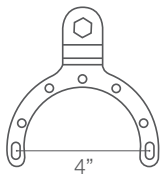

**RAM-B-411U**  
 Large Gas Tank Base

**BASES CONTINUED**

**Gas Tank Base**

This base is a low-profile way to get a unique perspective from your action camera or to attach your device where it can be easily accessed. Hardware is included for mounting to the fill port for stock tanks on most popular makes such as BMW, Honda, Kawasaki, Suzuki, and Yamaha.

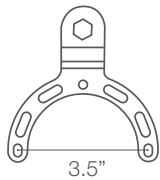

**RAM-B-410U**  
 Small Gas Tank Base

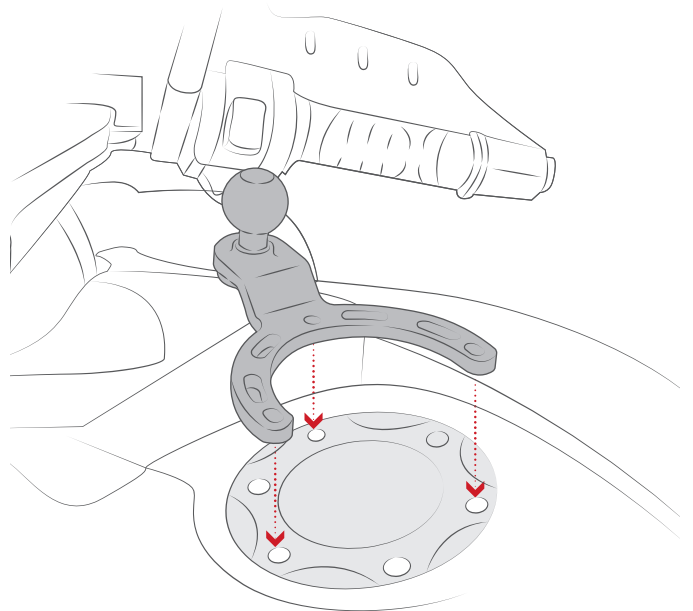

**SEEN IN THIS PHOTO:**

**RAM-B-349U**  
Threaded Ball Adapter

**RAM-B-201U-A**  
Short Double Socket Arm

**RAM-HOL-UN7BU**  
RAM® X-Grip® Phone Holder



**BASES CONTINUED**

**Threaded Ball Adapters**

Take advantage of your unused mirror sockets with these threaded bases, available with a M10 x 1.25 pitch male thread or a M10 x 1.5 pitch male thread. Both bases feature a RAM® B size ball that will connect to any B size double socket arm.

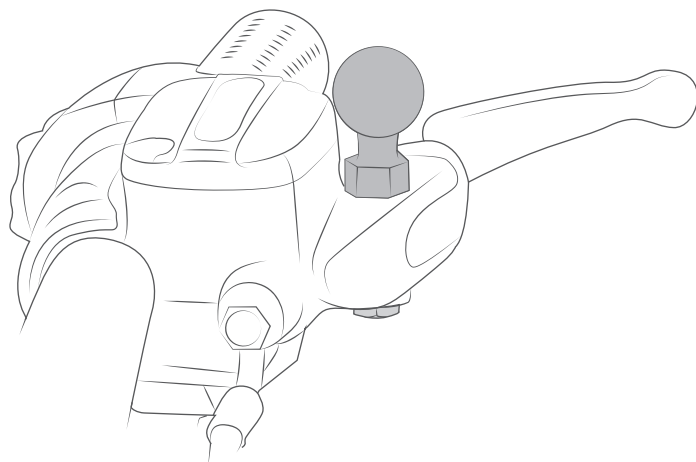

**RAM-B-349U**  
RAM® Ball Adapter with  
M10 X 1.25" Threaded Post



**RAM-B-236U**  
RAM® Ball Adapter with 3/8"-16  
Threaded Post



**BEST SELLER**  
**RAM-B-349-1U**  
RAM® Ball Adapter with  
M10 X 1.5" Threaded Post

**SEEN IN THIS PHOTO:**

---

**RAP-B-379-HA1U**

RAM® Tough-Ball™ for Harley-Davidson

**RAM-B-201U**

Medium Double Socket Arm

**RAP-B-202U-GOP1**

Universal Action Camera Adapter



**BASES CONTINUED**

## RAM® Tough-Ball™ for Harley-Davidson

The RAM® Tough-Ball™ low-profile mounting base is designed to mount directly through the mirror holes a Harley-Davidson. The included barrel nut enables you to mount the ball on top or below the hand grips where the mirror holes are located, helping to ensure a clear line of sight.

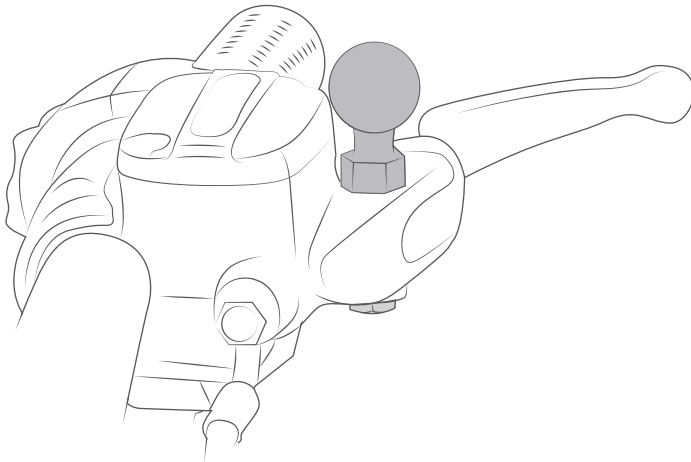

**BEST  
SELLER**

**RAP-B-379-HA1U**

RAM® Tough-Ball™ Mirror Base for  
Harley-Davidson Motorcycles

## RAM® Twist-N-Tilt™

The RAM® Twist-N-Tilt™ threads into the stock mirror location, giving users the ability to twist the mount 360 degrees, while the 1" ball can be tilted 180 degrees. Designed to be discrete and made of marine-grade aluminum, this versatile pivot base provides numerous mounting possibilities.

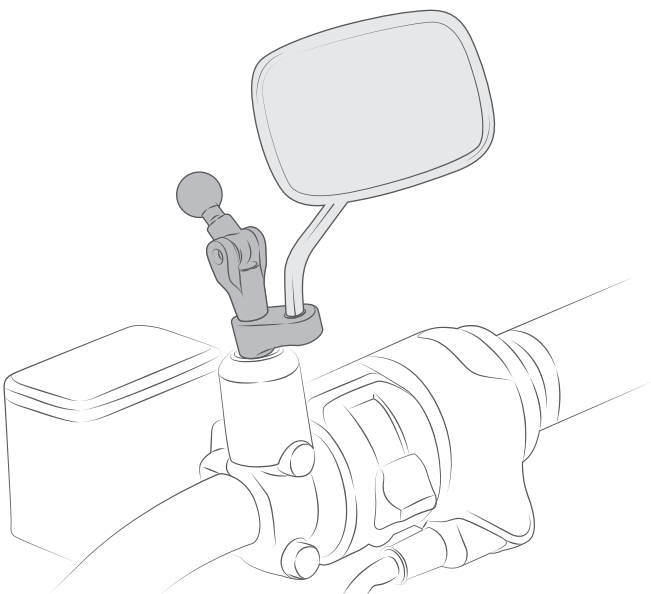

**RAM-B-360U**

RAM® Twist-N-Tilt™ Motorcycle Mirror Ball Base

SEEN IN THIS PHOTO:

**RAM-B-231-2-UN7U**

RAM® X-Grip® Phone Mount with ATV/  
UTV Rail Base



# UTV Mounting TOP SOLUTIONS

With popular clamping mounts such as the RAM® Tough-Claw™ and UTV hose clamp rail base, you can mount just about any device to your UTV. Locate the optimal section of your roll cage and simply clamp on one of these bases. Since most UTVs do not come equipped with a GPS unit, mounting ruggedized tablets are ideal when navigating trails. In addition, our trusted partners, Double Take Mirror, have developed RAM® Compatible™ mirrors to attach to your UTV, ATV, or dirt bike for a fully adjustable mirror system.

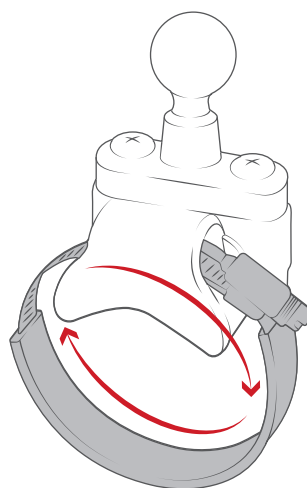

Accommodates most common rail and bar sizes on UTVs and ATVs

## PHONE



**RAM-B-231-2-UN7U**  
RAM® X-Grip® Phone Mount with ATV/UTV Rail Base



**RAM-B-231-2-UN10**  
RAM® X-Grip® Large Phone Mount with ATV/UTV Rail Base

## TABLET



**RAM-231Z-2-TABL20U**  
RAM® ATV/UTV Rail Mount for 9"-10.5" Tablets with Heavy Duty Cases



**RAM-231Z-2-TABL25U**  
RAM® ATV/UTV Rail Mount for 10" Tablets with Heavy Duty Cases

## CAMERA



**RAP-B-404-GOP1U**  
RAM® Tough-Claw™ Medium Clamp Mount with Universal Action Camera Adapter



**RAM-B-149Z-2-GOP1U**  
RAM® ATV/UTV Handlebar U-Bolt Mount with Action Camera Adapter

## CUP HOLDER



**RAM-B-417-200-1-231Z-2NUBU**  
RAM® Level Cup™ XL 32oz Drink Holder with Large Strap Clamp Base



**RAM-B-132R-2U**  
RAM® Level Cup™ 16oz Drink Holder with ATV/UTV Rail Base Clamp Base

## FEATURES

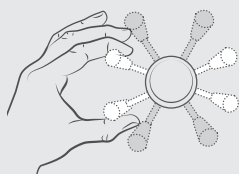

Highly adjustable

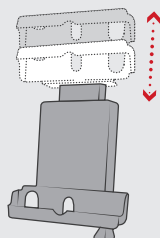

Adjustable to secure all tablets



Rubber ball dampens shock and vibration

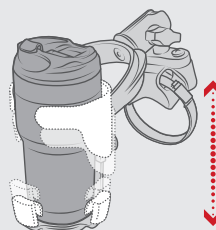

The oversized opening cradles the biggest of gulps and the adjustable bottom piece moves up and down to accommodate taller cups

SEEN IN THIS PHOTO:

**RAM-B-415-15-2U**

RAM® Torque™ 1 ½" - 2" Diameter Rail Base

**RAM-B-337-1U**

RAM® Add-A-Ball™ for RAM® Torque™ Large Rail Bases

**RAM-HOL-PD4-238AU**

RAM® Quick-Grip™ XL

**RAM-B-201U**

RAM® Double Socket Arm - B Size Medium

**RAP-B-202U-GOP1**

RAM® Action Camera Universal Ball Adapter

**RAM-B-201U-A**

RAM® Double Socket Arm - B Size Short



UTV MOUNTING CONTINUED

## ROLL BAR

The RAM® Tough-Claw™ is the perfect mounting base for quick installation and removal on round, square, and odd-shaped rails and bars—such as handlebars or roll cages. The RAM® Tough-Claw™ can be clamped on rails from .625" to 2.25" in diameter, making this an ideal solution for mounting action cameras, phones, and much more.

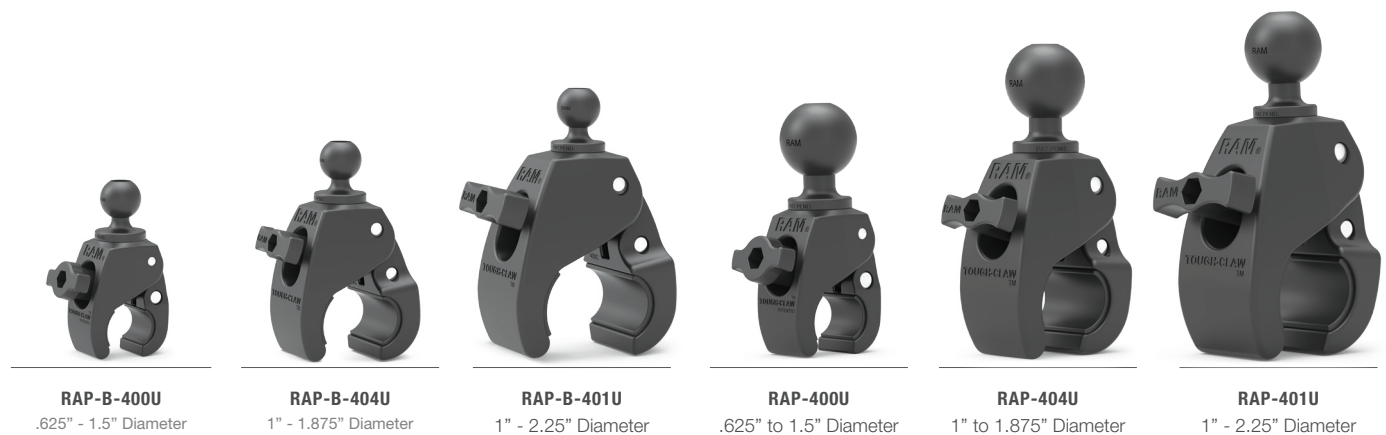
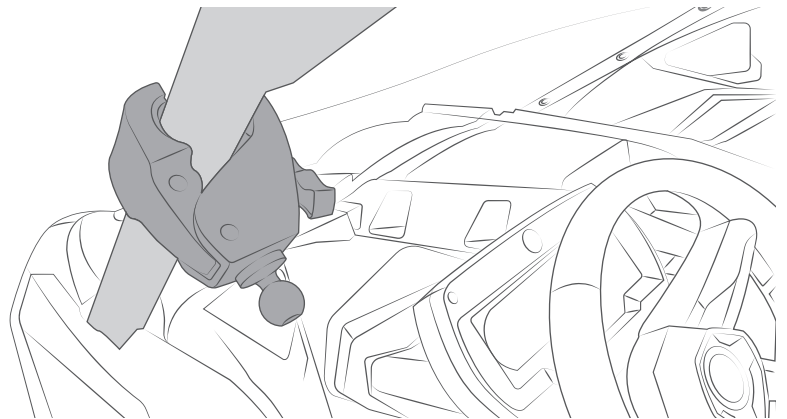





**RAM-B-231Z-2U**  
RAM® ATV/UTV Rail Ball Base  
for Rails up to 3.15" in Diameter



**RAM-B-108BU**  
RAM® Strap Hose Clamp Ball Base  
for Rails up to 2.1" in Diameter



**RAM-231Z-2U**  
RAM® ATV/UTV Rail Ball Base  
for Rails up to 3.15" in Diameter



**RAM-B-415-15-2U**  
RAM® Torque™ Rail Base  
1 1/2" - 2" Diameter



**RAM-351-415-15-2U**  
RAM® Torque™ Rail Base  
1 1/2" - 2" Diameter

**FEATURES**

Toolless installation for convenient installation, transfer and remove this base with the turn of a single knob

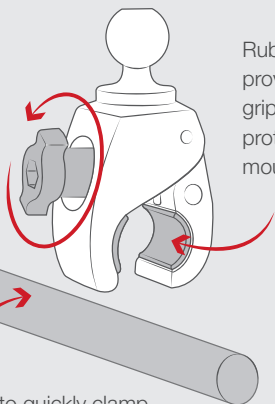

Rubber pads provide stable gripping and protection of the mounting surface

Designed to quickly clamp to round, square, and odd-shaped rails and bars

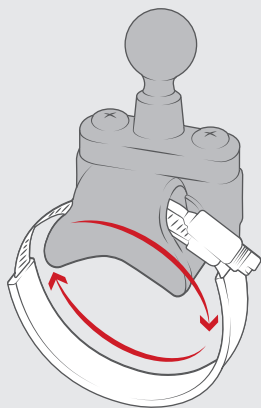

Accommodates most common rail and bar sizes on UTVs and ATVs

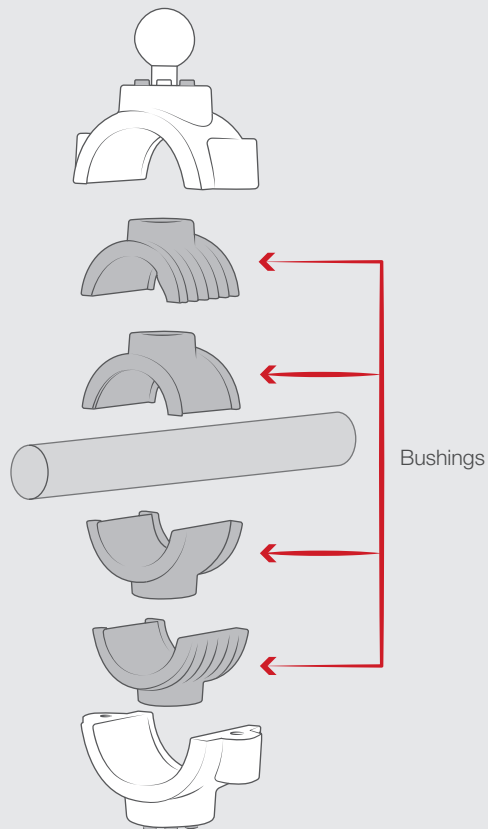

Internal bushings conform to your handlebar while protecting the surface



SEEN IN THIS PHOTO:

**RAM-B-149Z-GOP1U**  
RAM® Handlebar U-Bolt Double Ball  
Mount with Action Camera Adapter

# ATV Mounting TOP SOLUTIONS

Much like motorcycles, clamping mounts and the RAM® U-Bolt base are ideal for ATV mounting. Pair your device such as a GPS, phone, or rugged tablet with a compatible holder, double socket arm, and desired base. With RAM® Mounts, you're able to transfer your device holder to another base on another vehicle. That way you can equip all your different vehicles with a RAM® Mount so you only need a holder for your devices to swap them how you like.

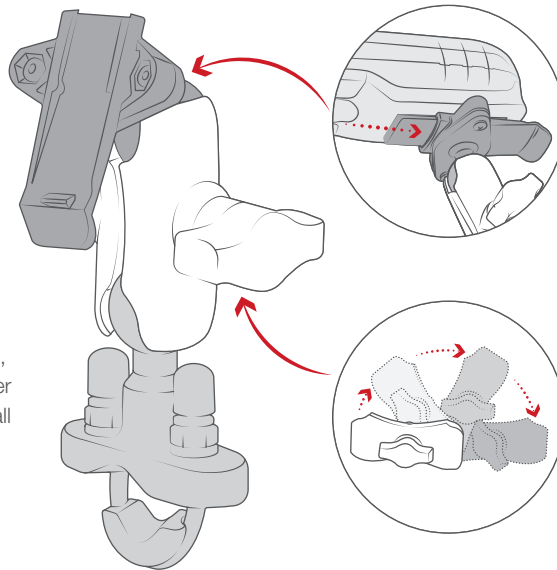

Holder secures any Garmin handheld device with an integrated spine connection

Ball and socket technology allows for near-infinite adjustability and perfect viewing angles



**BEST SELLER**

**RAM-B-149Z-A-PD4U**  
RAM® Quick-Grip™ XL  
Phone Mount with  
Handlebar U-Bolt Base



**RAM-B-149Z-A-GA76U**  
RAM® Spine Clip Garmin Mount  
with Handlebar U-Bolt Base



**RAM-B-400-A-GOP1U**  
RAM® Tough-Claw™ with Universal  
Action Camera Adapter



**RAM-400-B-UN8U**  
RAM® X-Grip® with  
RAM® Tough-Claw™ for  
7"-8" Tablets

## FEATURES

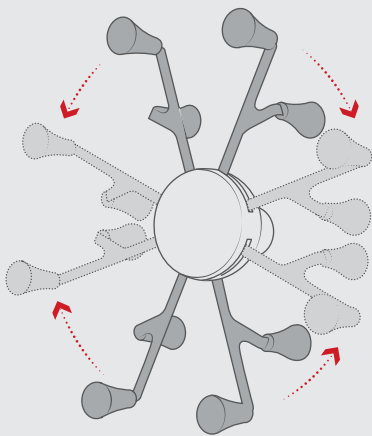

Highly adjustable to support tablets in portrait and landscape mode

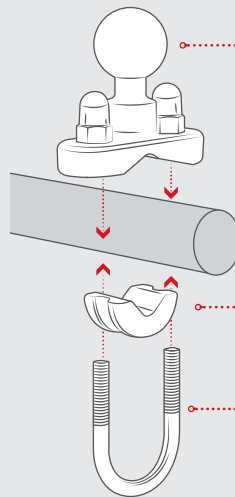

1" rubber ball is designed to sit at right angles on the mounting rail

U-Bolt spacer protects handlebar

Compatible with .5" - 1.25" handlebars

SEEN IN THIS PHOTO:

---

**RAM-B-149Z-A-PD3U**

RAM® Quick-Grip™ Phone Mount  
with Handlebar U-Bolt Base



# Dirt Bike/ Dual Sport RAM® QUICK-GRIP™

Bought and sold on six continents, riders from all over trust the RAM® X-Grip® and RAM® Quick-Grip™ holders to keep their phones secure and without interference of the handlebar controls or the rider's ability to turn their motorcycle. Nearly every location on the handlebars have a corresponding RAM® mounting base—from brake/clutch reservoir bases to mirror bases. Discover the many different motorcycle mounts RAM® carries for a wide variety of devices.

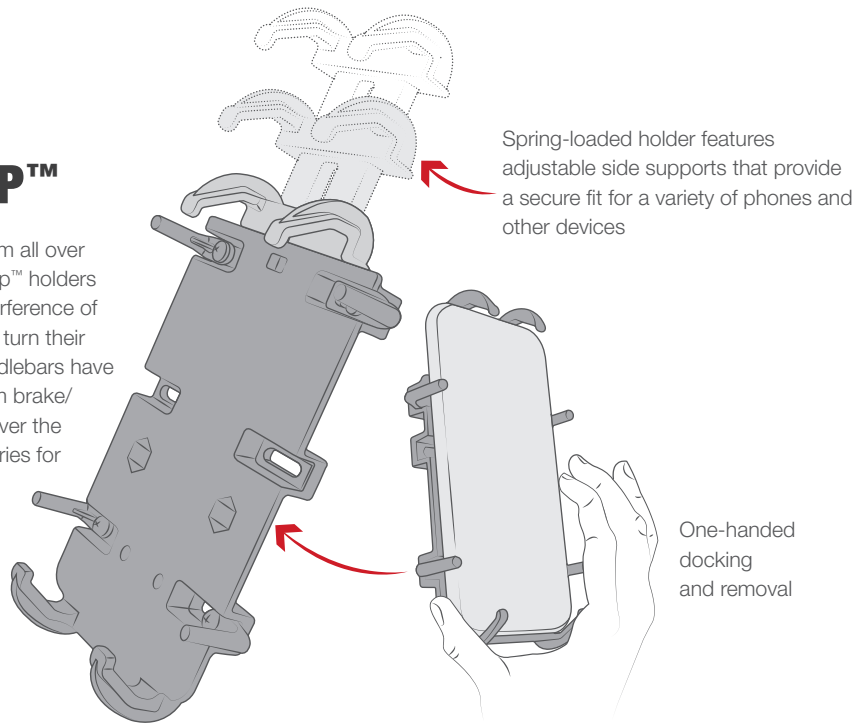

**RAM-B-149Z-A-PD3U**  
RAM® Quick-Grip™ Phone Mount with Handlebar U-Bolt Base

**BEST  
SELLER**



**RAM-B-149Z-A-PD4U**  
RAM® Quick-Grip™ XL Phone Mount with Handlebar U-Bolt Base



**RAM-B-149Z-A-UN14W-V7M**  
RAM® Quick-Grip™ Waterproof Wireless Charging with Handlebar U-Bolt Base



**RAM-B-400-A-UN14W-V7M**  
RAM® Quick-Grip™ Waterproof Wireless Charging Mount with Tough-Claw™

## FEATURES

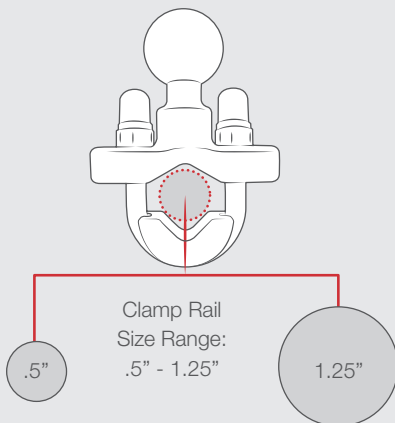

Spring-loaded RAM® Quick-Grip™ design

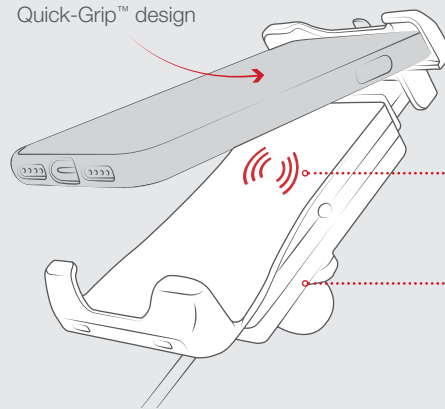



SEEN IN THIS PHOTO:

**RAM-B-400-A-UN12W-V7M**  
RAM® Tough-Charge™  
Waterproof Wireless Charging  
Mount with Tough-Claw™



SEEN IN THIS PHOTO:

**RAM-B-149Z-A-UN7U**  
RAM® X-Grip® Phone Mount  
with Handlebar U-Bolt Base

# RAM® X-GRIP™

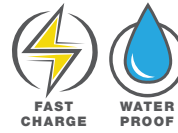

For over 20 years, the RAM® X-Grip® is still the king of the road, being the ideal pairing for motorcycle phone mounting. Some of the top kits to pair with the RAM® X-Grip® include the brake/clutch reservoir base, RAM® Tough-Claw™, and U-Bolt base. Secure your phone on and off the road with the spring-loaded RAM® X-Grip® holder and safety tether.



**BEST  
SELLER**

**RAM-B-400-A-UN12W-V7M**  
RAM® Tough-Charge™ Waterproof Wireless Charging Mount with Tough-Claw™

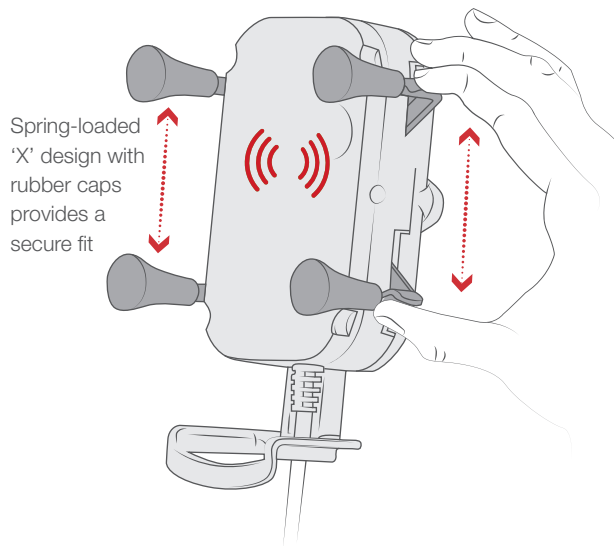

**RAM-B-149Z-A-UN7U**  
RAM® X-Grip® Phone Mount with Handlebar U-Bolt Base

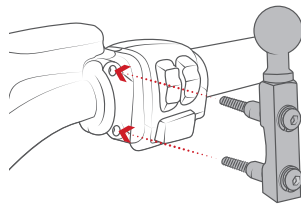

**RAM-B-174-A-UN10U**  
RAM® X-Grip® Large Phone Mount with Brake/Clutch Reservoir Base



**RAM-B-400-A-HOL-UN7BU**  
RAM® X-Grip® Phone Mount with RAM® Tough-Claw™ Small Clamp Base

## FEATURES

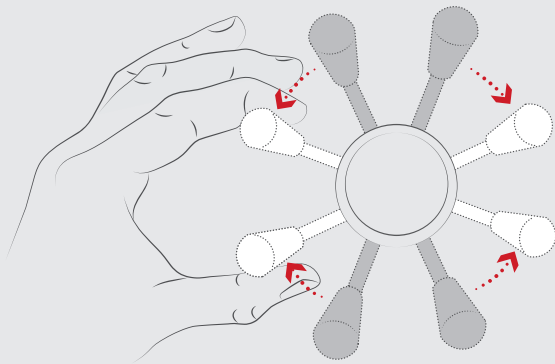

Spring-loaded 'X' design with rubber caps provides a secure fit

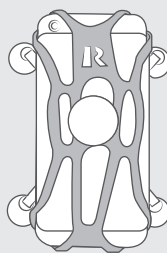

Includes safety tether for extra peace of mind

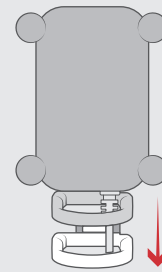

Includes adjustable support leg

SEEN IN THIS PHOTO:

**RAP-B-400-GOP1U**  
RAM® Tough-Claw™ Double  
Ball Mount with Universal  
Action Camera Adapter





DIRT BIKE/DUAL SPORT CONTINUED

# TOP SOLUTIONS

Take advantage of fully articulating GoPro® mounts for motorcycles and capture any angle that the GoPro® OEM base can't achieve. With a simple turn of the knob, rotate your action camera to the exact position you want. Our ball and socket technology dampens shock and vibration that enables the camera's image stabilization to give you the smoothest video.

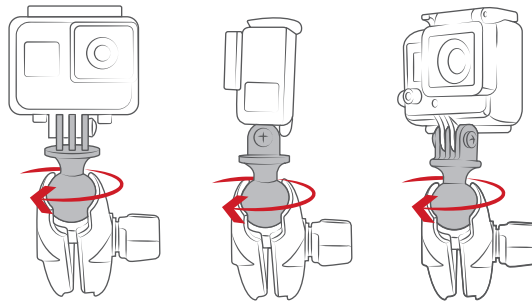

Adjust the position of your camera with the turn of a single knob



**RAM-B-149Z-A-GOP1U**  
RAM® Handlebar U-Bolt Double Ball Mount with Action Camera Adapter



**RAM-B-149Z-GOP1U**  
RAM® Handlebar U-Bolt Double Ball Mount with Action Camera Adapter



**RAP-B-400-GOP1U**  
RAM® Tough-Claw™ Double Ball Mount with Universal Action Camera Adapter



**RAP-B-400-A-GOP1U**  
RAM® Tough-Claw™ Small Clamp Mount with Universal Action Camera Adapter

## FEATURES

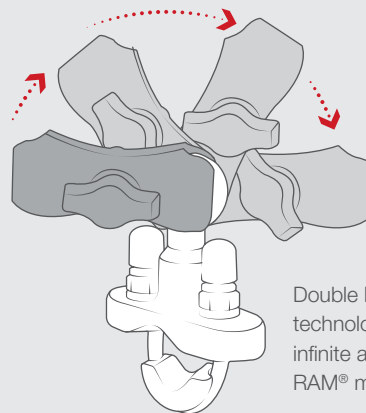
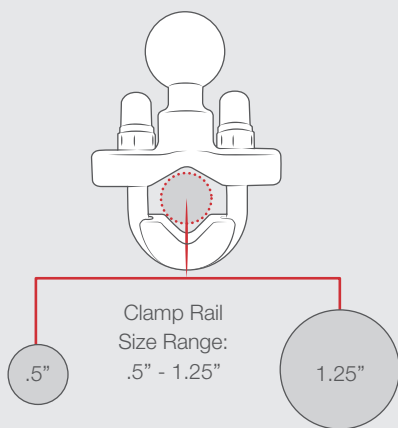

Double ball and socket technology allows for near-infinite adjustability of your RAM® mounting system

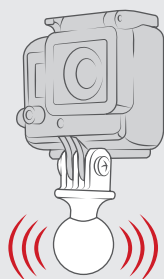

Rubber ball dampens shock and vibration

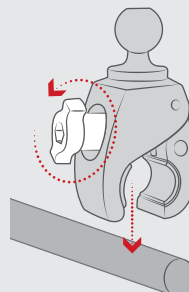

Toolless installation for convenient installation, transfer and removal of base

SEEN IN THIS PHOTO:

**RAM-B-149Z-SP06U**

RAM® EZ-Roll'r™ Handlebar U-Bolt Mount for SPOT Gen4



**DIRT BIKE/DUAL SPORT CONTINUED**

**TOP SOLUTIONS**

Dual sport riders go on extensive adventures, and GPS tracking devices like the SPOT Gen4 have become off-roading essentials. The RAM® EZ-Roll'r™ cradle features one-handed insertion of your SPOT Gen4 and leaves all buttons and ports exposed. No matter which handheld satellite tracker you have, stay safe on your motorcycle by pairing it with an ultra-rugged mount.

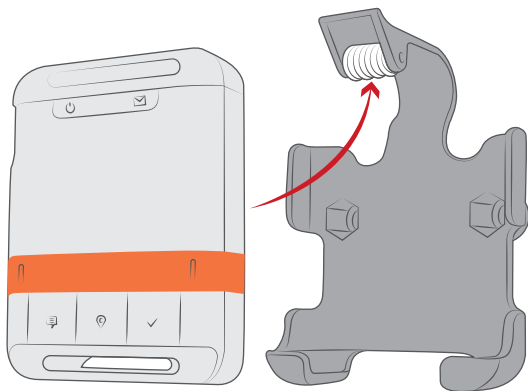

Simply slide your SPOT Gen4 into the cradle and roll the top clip over the device to secure into place.



**RAM-B-149Z-A-GA76U**  
 RAM® Spine Clip Garmin Mount with Handlebar U-Bolt Base



**RAM-B-400-GA76U**  
 RAM® Tough-Claw™ Small Clamp Mount with Garmin Spine Clip Holder



**RAM-B-400-SP06U**  
 RAM® Tough-Claw™ Small Clamp Mount for SPOT Gen4



**RAM-B-149Z-SP06U**  
 RAM® EZ-Roll'r™ Handlebar U-Bolt Mount for SPOT Gen4

**FEATURES**

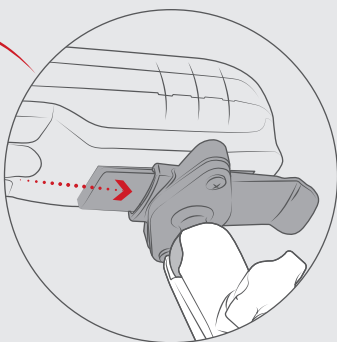
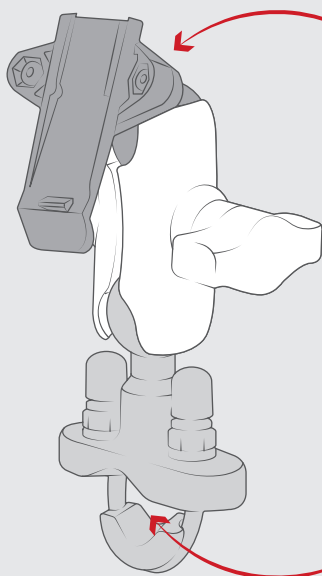

Holder secures any Garmin handheld device with an integrated spine connection

Clamp Rail Size Range: .5" - 1.25"

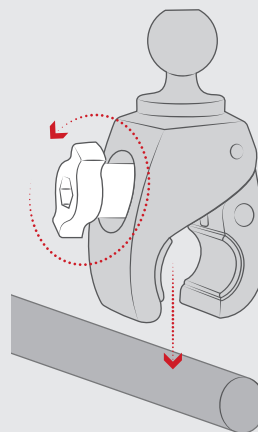

Toolless installation for convenient installation, transfer, and removal of base



SEEN IN THIS PHOTO:

**RAM-B-202-GA76U**

RAM® Spine Clip Holder with Ball for Garmin Handheld Devices

**RAM-B-201U-A**

RAM® Double Socket Arm

**RAM-B-236U**

RAM® Ball Adapter with 3/8"-16 Threaded Post

**DIRT BIKE/DUAL SPORT CONTINUED**

**BASES**

There are many handlebar locations to mount a phone, camera, or GPS unit, and RAM® Mounts has mounting solutions for all of them. From threaded posts, bolt heads, mirror adapters, and fork stems, RAM® has a base suited for your custom mounting solution. Attach any length B size RAM® double socket arm and you're one step away from your new mount.

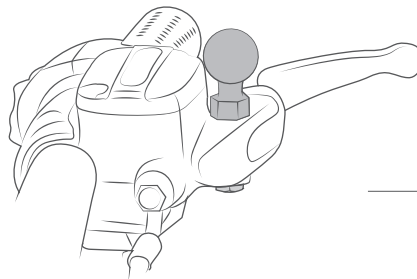

**RAM-B-349U**  
RAM® Ball Adapter with  
M10 X 1.25 Threaded Post



**RAM-B-236U**  
RAM® Ball Adapter with  
3/8-16 Threaded Post



**RAM-B-349-1U**  
RAM® Ball Adapter  
with M10 X 1.5  
Threaded Post



**RAM-B-367U**  
RAM® Motorcycle Handlebar Clamp Base with M8 Bolts

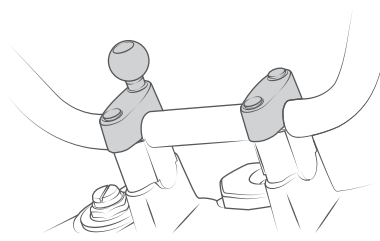

**RAM-B-400U**  
RAM® Tough-Claw™ Small Clamp  
Base with Ball



**RAM-B-231ZU**  
.5" to 1.25" Diameter  
Single U-Bolt Base

**BEST  
SELLER**



**RAM-B-309-7U**  
RAM® Motorcycle Brake/Clutch Reservoir & Handlebar Ball Base

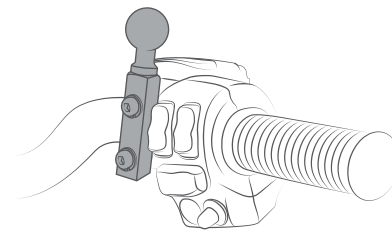

**FEATURES**

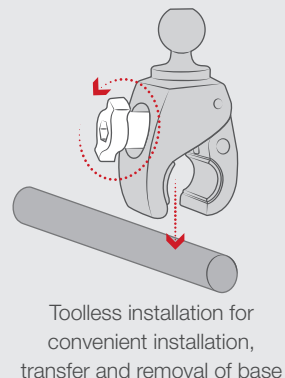
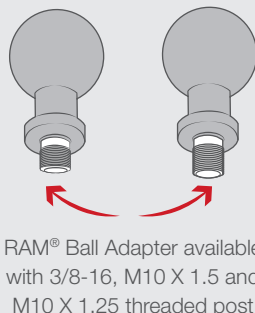
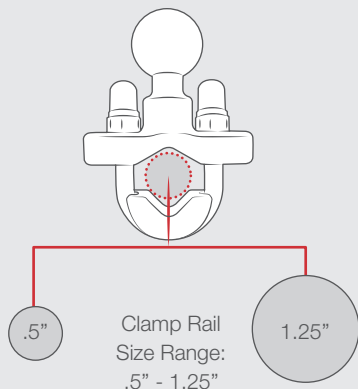

SEEN IN THIS PHOTO:

**RAM-B-400-A-GOP1U**

RAM® Tough-Claw™ Small Clamp Mount  
with Universal Action Camera Adapter



# Snowmobile TOP SOLUTIONS

No dirt? No problem. Snowmobiles are much like ATVs with a plethora of handlebar mounts to choose from. Ensure safety out on the snow with GPS tracking mounts and handheld radio mounts in situations where you get stuck, or worse. RAM® Mounts carries the most trusted products for securing your devices when you truly need them for just about any environment or application.

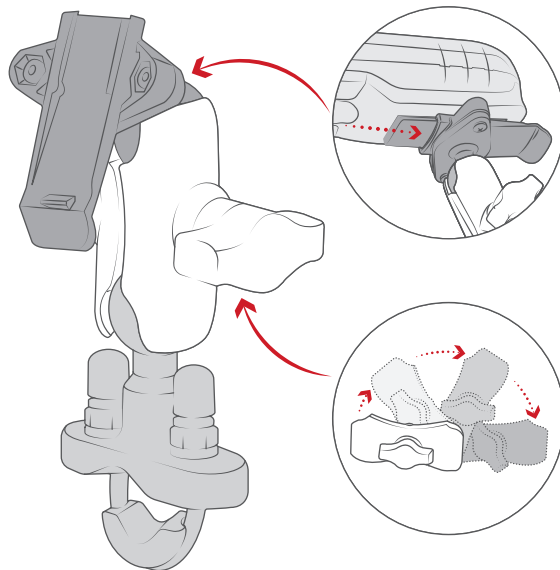

Holder secures any Garmin handheld device with an integrated spine connection

Ball and socket technology allows for near-infinite adjustment and perfect viewing angles



**BEST SELLER**

**RAM-B-149Z-A-PD4U**  
RAM® Quick-Grip™ XL  
Phone Mount with  
Handlebar U-Bolt Base



**RAM-B-149Z-A-GA76U**  
RAM® Spine Clip Garmin Mount  
with Handlebar U-Bolt Base



**RAM-B-400-A-GOP1U**  
RAM® Tough-Claw™ Small Clamp  
Mount with Universal Action  
Camera Adapter



**RAM-400-B-UN8U**  
RAM® X-Grip® with  
RAM® Tough-Claw™ Small Mount  
for 7"-8" Tablets

## FEATURES

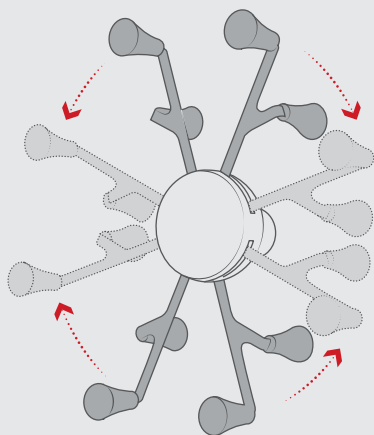

Highly adjustable to support tablets in portrait and landscape mode

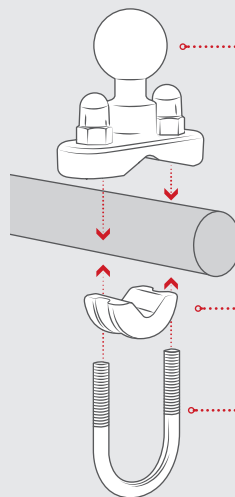

1" rubber ball is designed to sit at right angles to mounting rail

U-Bolt spacer protects handlebar surface

Compatible with any .5" - 1.25" handlebar

SEEN IN THIS PHOTO:

**RAM-B-309-7U**  
Brake/Clutch Reservoir Base

**RAM-B-201U**  
Medium Double Socket Arm

**RAM-HOL-UN7BU**  
RAM® X-Grip® Phone Holder





# Accessories & More ARMS

RAM® Mounts double socket arms are available in short, medium, and long lengths, and pair perfectly with ball bases. Choose your desired arm length and ball size, the most popular being B (1") and C size (1.5").

Almost all RAM® Mounts you've seen have likely been all black. But our chrome double socket arms—available only in B size - are the perfect match for motorcycle handlebars.

If you're looking for 360-degree rotation and unsurpassed adjustability, the RAM® Composite Double Socket Swivel Arm consists of two 1" open ball sockets and a rotation point at the center of the arm.

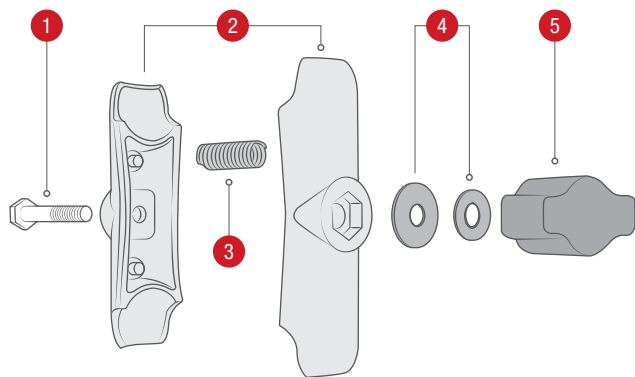
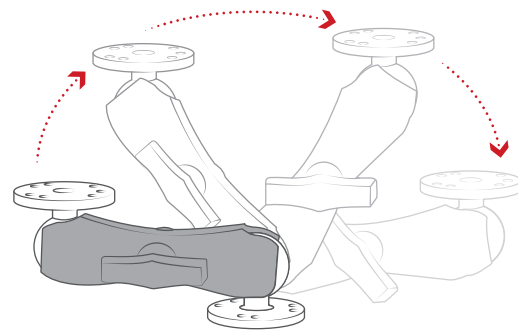

- 1 Center bolt bridges the gap between both halves of the socket arm
- 2 Ball and socket technology allows for near-infinite adjustment and perfect viewing angles.
- 3 A single spring inside the arm opens the end sockets, allowing you to pivot the ball and socket connection.
- 4 Stainless steel and nylon washers ensure smooth and secure friction when tightening your mount.
- 5 High strength knob with brass threading keeps your mount tight for the long term.



**RAM-B-201U-A**  
Overall length: 2.38"  
Socket-to-socket: 1.75"



**BEST SELLER**  
**RAM-B-201U**  
Overall length: 3.69"  
Socket-to-socket: 3"



**RAM-B-201U-C**  
Overall length: 6"  
Socket-to-socket: 5.25"



**RAM-B-201-ACHU**  
Overall length: 2.38"  
Socket-to-socket: 1.75"



**RAM-B-201CHU**  
Overall length: 3.69"  
Socket-to-socket: 3"



**RAP-B-200-12U**  
Overall length: 4.25"  
Socket-to-socket: 3.625"



**RAP-B-200-2U**  
Overall length: 6.25"  
Socket-to-socket: 5.625"

**SEEN IN THIS PHOTO:**

---

**RAM-B-408-112-15-238U**

RAM® Torque™ Handlebar Mount

**RAM-HOL-PD3-238AU**

RAM® Quick-Grip™ Phone Holder

**RAM-B-273U**

RAM® Add-A-Ball™ Accessory

**RAM-B-201U-A**

Short Double Socket Arm

**RAP-B-202U-GOP1**

Universal Action Camera Adapter



## FEATURES

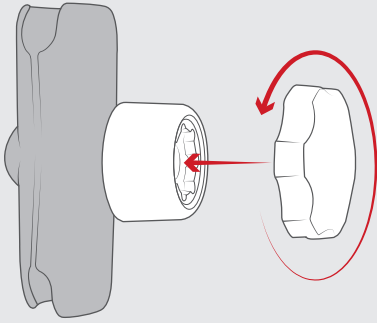

The RAM® Pin-Lock™ Security Knob offers the ideal amount of leverage on C size arms to properly tighten and secure your mount from theft and tampering

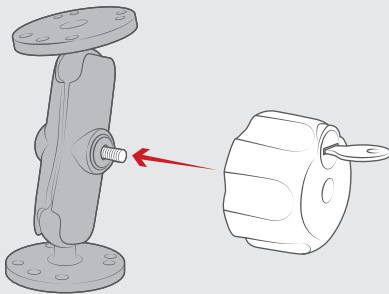

The RAM® Key Lock Knob allows you to swap the standard knob on your B size arm with a key-locking version. Once you have set your mount in the location you need, lock it in place and feel secure knowing that your mounted device will stay right where you left it

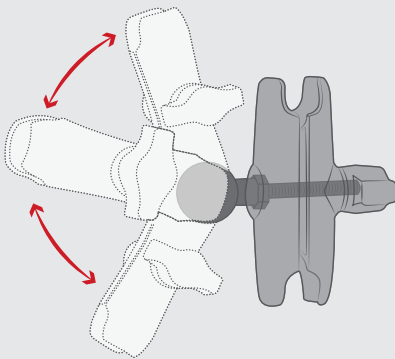
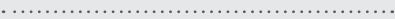

The RAM® Add-A-Ball™ adds an extra connection to any B size double socket arm, allowing you to mount a second device side by side

## ACCESSORIES & MORE CONTINUED

# ARM ACCESSORIES

With the RAM® Mounts Add-A-Ball™, connect another device to your double socket arm by utilizing this 1" accessory ball.

To connect two arms, use the RAM® Double Ball Adapter.

By using the RAM® Pin-Lock™ Security Knob or RAM® Key Lock Knob, you can replace all knobs on B and C size arms to prevent theft and tampering of your electronics. When outfitting a fleet, the RAM® Pin-Lock™ can be keyed alike.

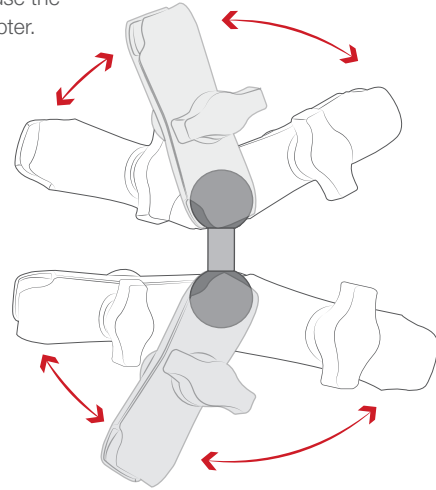

The perfect adapter for connecting two B size RAM® Mounts double socket arms for extra extension or articulation



**RAM-B-230U**  
RAM® Double Ball Adapter



**RAM-S-KNOB3U**  
RAM® Pin-Lock™ Security Knob  
for B Size Socket Arms



**RAM-KNOB3LU**  
RAM® Key Lock Knob with  
Brass Insert for B Size  
Socket Arms

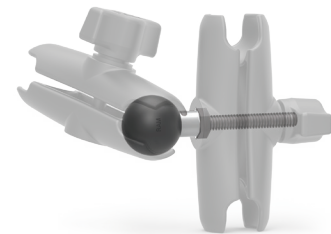

**BEST SELLER**  
**RAM-B-273U**  
RAM® Add-A-Ball™  
Accessory Ball  
for B Size Socket Arms



**SEEN IN THIS PHOTO:**

**RAM-B-408-75-1-A-417U**

RAM® Level Cup™ XL 32oz Drink Holder with RAM® Torque™  
Medium Rail Base

# DRINK HOLDER MOUNTS

Grab your drink and hit the road! The RAM® Level-Cup™ is a self-leveling drink holder that comes in two sizes—16oz and 32oz. No matter how harshly you drive or ride your motorcycle, the Level-Cup™’s self-leveling technology keeps your beverages in the cup and not all over the ground, or on you.

## FEATURES



Self-leveling swivel mount prevents spills

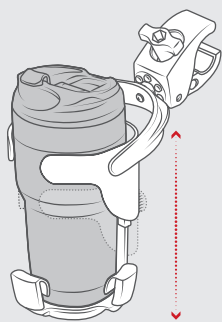

Height adjusts for 32oz holder



### RAM-B-132-400U

RAM® Level Cup™ 16oz Drink Holder with RAM® Tough-Claw™ Mount

16oz drink compatibility



### RAM-B-408-75-1-A-132U

RAM® Level Cup™ 16oz Drink Holder with RAM® Torque™ Medium Rail Base



### RAM-B-132RU

RAM® Level Cup™ 16oz Drink Holder with Handlebar U-Bolt Base



### RAM-B-417B-C-354-TRA1U

RAM® Level Cup™ XL 32oz Drink Holder with RAM® Track Ball™ Base

**BEST  
SELLER**



### RAP-B-417-400U

RAM® Level Cup™ XL 32oz Drink Holder with RAM® Tough-Claw™



### RAP-B-417BU

RAM® Level Cup™ XL 32oz Drink Holder with Ball

SEEN IN THIS PHOTO:

**RAM-B-149Z-UN4U**

RAM® Finger-Grip™ Universal Mount with Handlebar U-Bolt Base



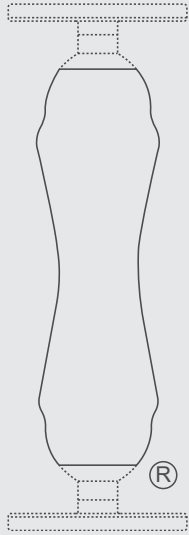

## THE SHAPE That Started It All

RAM® double socket arms with their distinctive Hourglass Shape are recognized globally as a symbol of the reliability, quality, and durability of this line of products. The Hourglass Shape is a registered trademark of National Products Inc.



## LEARN MORE

The unique RAM® Mounts system offers a full line of interchangeable mounting bases, extensions, device adapters, and accessories to secure your devices where you want them. See all of the innovative products and solutions RAM® manufactures at [rammount.com](http://rammount.com).

RAM® Mounts is a division of National Products Inc.  
8410 Dallas Avenue South  
Seattle, WA 98108  
Phone: 800.497.7479  
[sales@rammount.com](mailto:sales@rammount.com)  
[rammount.com](http://rammount.com)

Lifetime Warranty  
Patents and Trademarks  
[rammount.com/ip](http://rammount.com/ip)



**THE DISTINCTIVE "D" PRODUCT SHAPE**  
of the GDS® connector is a trademark of National Products Inc.



**THE DISTINCTIVE RAM® "X-GRIP®"**  
product shape is a trademark of National Products Inc.



Look for the highly recognizable "Double Delta" trademark, the symbol of quality and reliability



## CONTACT US

[sales@rammount.com](mailto:sales@rammount.com)

1-800-497-7479

## JOIN OUR COMMUNITY



**NPI-CAT-POWERSPORTS22**

December 2022

