



RAM[®] MOUNTS

Material Handling



Welcome to the

CONNECTED WAREHOUSE

For over 30 years, RAM® Mounts has collaborated with the industry's best innovators to build the future of mobility. The key to a mobile workforce combines device, software, and docking solution. That's why we created the Connected Warehouse—a commitment to making the most reliable and affordable device mounts, paired with the best solutions providers in the world. Every day our engineering teams look for ways to optimize product performance to seamlessly integrate into one another, making the lives of workers worldwide easier, and business logistics scalable.



CONNECTED
WAREHOUSE



Device

Every journey starts with a device. With it, the new age of the connected worker is possible.

SAMSUNG

motorola

Honeywell

ivanti

ZEBRA

Getac

HYSTER-YALE

StayLinked

POWERFLEET

CUBISCAN

SOTI

DATALOGIC

Stoneridge

SICK

MobileDemand

PROGLOVE

RAYMOND

Apple

COLLECTIVE INTELLIGENCE GROUP

brother

VIA

TOYOTA MATERIAL HANDLING

Logisnext

CROWN

Software

Industry standard software ensures compatibility across the device and docking station.



GDS® Tech™

Enable a highly mobile workforce with powered docking stations and ergonomic accessories.



The Industry Standard

National Products, Inc. has supplied the most rugged and connective mobile device mounting systems on the planet. With the globally recognized RAM® Mounts, award-winning GDS® Tech™ and IntelliSkin® product lines, executing NPI's mission to bring world-class mounting solutions to real-world applications has become essential to success in all industries—we are the industry standard.



Contents

About

- 5 How it Works: RAM® Mounts
- 7 How it Works: IntelliSkin® & GDS® Tech™
- 15 RAM® vs. GDS®

Brands

- 17 Brands

Magnetic Mounting

- 19 Magnetic Mounts

Forklift Mounting

- 21 Forklift Mounts

Yard & Terminal

- 27 Container Movement
- 31 Digital Check-in & Automated Gates
- 33 Dock Management
- 35 Yard Jockey
- 37 Digital Bill of Lading (BOL)

Manufacturing

- 41 Work Order Management
- 45 Packaging
- 47 Quality Inspection
- 49 Time Clocks
- 51 Assembly Line
- 53 Maintenance

Warehousing

- 55 Forklift
- 61 Order Picking
- 65 Pallet Jacks & Carts
- 69 Management

Shipping

- 71 Bill of Lading (BOL)
- 75 Pallet Management

Chargers

- 79 Hardwire Chargers



How it Works: RAM® Mounts

Double Ball Mounts

Choose from a selection of holders, socket arms and ball bases to build a custom mount for your specific needs. Additional bases may be chosen so that your mount can support multiple devices, or can be transferred to alternate mounting locations.

1

CHOOSE A BASE

Select from a variety of bases to secure your device exactly where you need it

2

CHOOSE AN ARM

Select an arm based on your desired length and placement

3

CHOOSE AN ADAPTER

Select an adapter based on the weight of your device and holder

4

CHOOSE A HOLDER

RAM® offers a wide selection of holders for your specific device

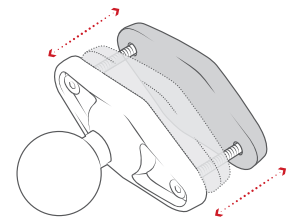
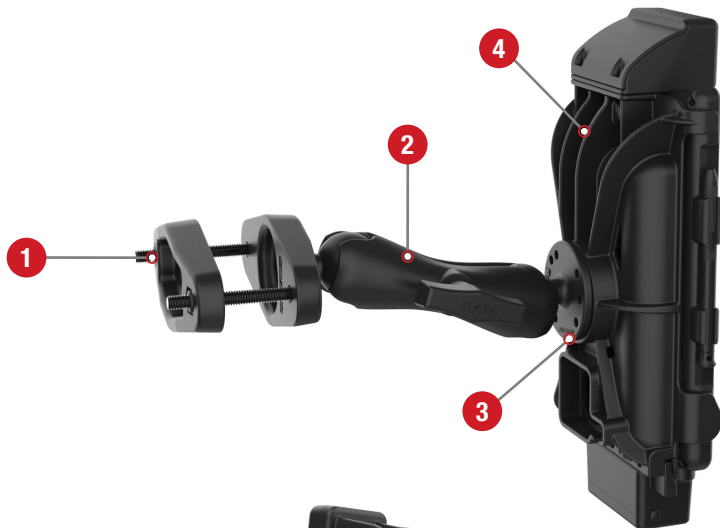

Easily adjustable

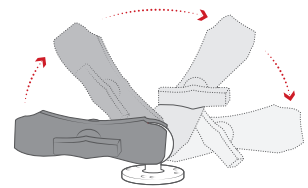

Double ball and socket technology allows for near-infinite adjustability

2-Hole AMPS

Intended for small devices and light duty environments

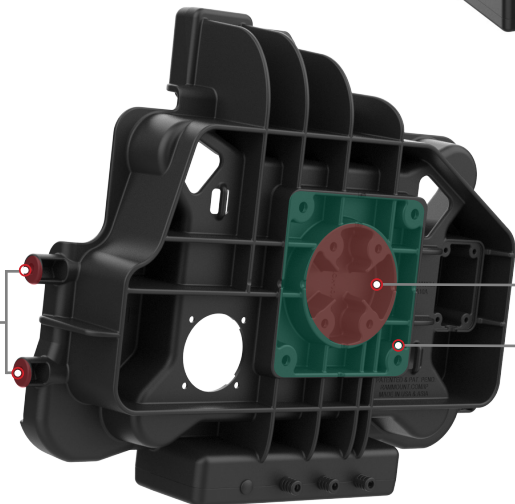

4-Hole AMPS & VESA Pattern

Intended for large devices and heavy duty environments

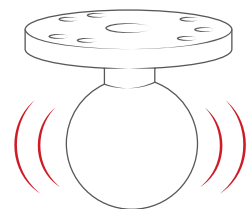

Rubber casing absorbs shock and damps vibration

Bases

Each ball size in the RAM® Mounts rubber ball and socket system supports a different amount of weight and withstands increasingly intense vibration. Use the examples below to determine the ideal size for your system based on your device weight and application.



B SIZE

- 1" diameter ball
- Holds up to 1 lb
- Ideal for cup holders, cameras, phones, and other lightweight devices



C SIZE

- 1.5" diameter ball
- Holds up to 3 lbs
- Ideal for tablets, 2D barcode scanners, & lightweight laptops



D SIZE

- 2.25" diameter ball
- Holds up to 5 lbs
- Ideal for vehicle-mounted computers and rugged laptops in moderate vibration environments



E SIZE

- 3.38" diameter ball
- Holds up to 10 lbs
- Ideal for vehicle-mounted computers and rugged laptops in extreme vibration environments

Socket Arms

RAM® Mounts feature a double ball and socket system that provides modularity and adjustability. The RAM® arm connects the mounting base and your device. Arms are available in various sizes and lengths—make sure to shop within your intended size ecosystem.



B SIZE 1"

PART NUMBER	OVERALL LENGTH	SOCKET TO SOCKET
RAM-B-201U-A	2.42"	1.75"
RAM-B-201U	3.73"	3.00"
RAM-B-201U-C	6.00"	5.31"



C SIZE 1.5"

PART NUMBER	OVERALL LENGTH	SOCKET TO SOCKET
RAM-201U-B	3.56"	2.50"
RAM-201U	5.69"	4.66"
RAM-201U-D	9.13"	8.00"



D SIZE 2.25"

PART NUMBER	OVERALL LENGTH	SOCKET TO SOCKET
RAM-D-201U-C	5.10"	3.60"
RAM-D-201U	8.44"	6.88"
RAM-D-201U-E	12.98"	11.41"



E SIZE 3.38"

PART NUMBER	OVERALL LENGTH	SOCKET TO SOCKET
RAM-E-201U-D	7.31"	4.97"
RAM-E-201U	12.625"	9.875"

How it Works: IntelliSkin® & GDS® Tech™

IntelliSkin®

Take your workplace efficiency to the next level with an IntelliSkin® protective sleeve. This case features an integrated USB-C connector with external pogo pads, unlocking the GDS® Ecosystem™ of vehicle docks, desktop docks, peripheral devices, and ergonomic accessories.

IntelliSkin® Next Gen

ERGONOMIC ACCESS

For GDS® Uni-Conn™ Adapter or Hand Strap Accessories

POSITIONING MARKER

For a seamless docking experience



POGO PADS

Protect device ports from constant plugging and unplugging, flat for easy cleaning

D-SHAPED PLATFORM

Universal platform ensures seamless fit between GDS® Docks™ and all IntelliSkin® cases

USB TYPE-C PORT

Integrated connector allows for charging even when a GDS® Dock™ is not available

Supports Your Favorite Brands

Apple



Samsung



Zebra



GDS® Tech™

The GDS® Tech™ platform provides protection, charging, and data sync capabilities across a wide range of electronic devices, making it a perfect solution for fleet deployment. With GDS® Compatible™ IntelliSkin® protective sleeves, GDS® Docks™, and GDS® Ecosystem™ accessories, simplify the process of scaling and upgrading devices while taking advantage of a standardized charging and data transfer ecosystem.



Always Protected, Always Connected.®



HOW IT WORKS: INTELLISKIN® & GDS® TECH™

GDS® Uni-Conn™

GDS® Uni-Conn™ is a universal, snap-in docking system that eliminates the need for expensive device upgrades. With just an IntelliSkin®-wrapped device and a GDS® Uni-Conn™ adapter, you're ready to connect seamlessly. This system not only streamlines the upgrade process but also makes docking effortless. When it's time for your next device upgrade, remember: there's only **One Dock to Connect Them All™**.

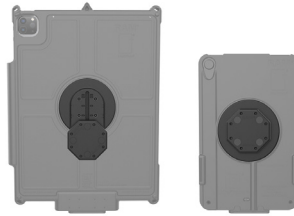

GDS® UNI-CONN™ ADAPTERS FOR INTELLISKIN®

Unlock the potential of GDS® Uni-Conn™ by installing the adjustable button adapter (RAM-GDS-U1AU) or standard adapter (RAM-GDS-U1U) to the back of your IntelliSkin®.

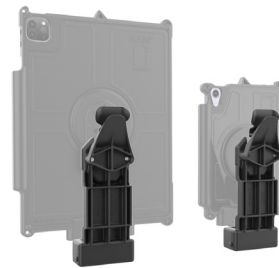

SEAMLESS DEVICE UPGRADES FOR THE FUTURE

Each IntelliSkin® is designed with the alignment point at the same height to connect with one universal docking station. When the time comes to upgrade devices in your fleet, a new IntelliSkin® is all that is needed. *Note: failure to install dock lever stop will void warranty.*



SPRING LOADED FOR BACKWARDS COMPATIBILITY

For most IntelliSkin®-wrapped tablets outside of the listed compatible devices, a spring loaded version of the GDS® Uni-Conn™ dock is available so you can implement this solution ahead of your next device upgrade.

GDS® Uni-Conn™ Dock Compatibility

IntelliSkin® Next Gen



IPADS

- iPad 10th Gen
- iPad Air 4-5
- iPad Air 11" (M2)
- iPad Air 13" (M2)
- iPad mini 6
- iPad Pro 12.9" (3-6th Gen)
- iPad Pro 11" (1-4th Gen)
- iPad Pro 11" (M4)
- iPad Pro 13" (M4)



GALAXY TABLETS

- Galaxy Tab A 8.0 (2018)
- Galaxy Tab A 8.0 (2019)
- Galaxy Tab A 8.4
- Galaxy Tab A 10.1
- Galaxy Tab A 10.5
- Galaxy Tab A7 Lite
- Galaxy Tab A7 10.4
- Galaxy Tab A8 10.5
- Galaxy Tab A9+
- Galaxy Tab Active4 Pro, Pro
- Galaxy Tab S7-S9FE

IntelliSkin® Thin-Case™



IPADS

- iPad 10th Gen
- iPad Air 11" (M2)
- iPad mini 6
- iPad Pro 12.9" (3-6th Gen)
- iPad Pro 11" (1-4th Gen)
- iPad Pro 11" (M4)



GALAXY TABLETS

- Galaxy Tab A9+
- Galaxy Tab Active5
- Galaxy Tab Active3
- Galaxy Tab S9+
- Galaxy Tab S9+ FE

IntelliSkin® Hard Case



RAM-GDS-SKIN-SAM89-HC
 IntelliSkin® Hard Case for Samsung Tab Active5, 3, 2



RAM-GDS-SKIN-SOM1HC
 IntelliSkin® Hard Case for Social Mobile RHINO T80



RAM-GDS-U1-ZE20U
 GDS® Uni-Conn™ Adapter for Zebra ET40/ET45 8"



RAM-GDS-U1-ZE21U
 GDS® Uni-Conn™ Adapter for Zebra ET40/ET45 10"

Compatible Accessories

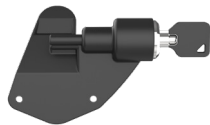

RAM-LOCK-U1LRU
 GDS® Right Facing Lock Adapter for Snap-In Docks



RAM-HOL-U1LRU
 RAM® Right-Locking Holder with GDS® Uni-Conn™ Button



RAM-HOL-U1U
 RAM® Holder for Tablets with GDS® Uni-Conn™ Button



RAM-GDS-U1HSU
 GDS® Hand Strap with Uni-Conn™ Adapter

HOW IT WORKS: INTELLISKIN® & GDS® TECH™

Input Devices

GDS® Tech™ supports peripheral enablement and allows users to connect peripherals directly to their device. With a variety of accessories available in the GDS® Ecosystem™, you can easily swap as the needs of your company grow.



EASILY CONNECTS TO YOUR:



KEYBOARD



SCANNER

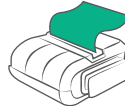

PRINTER

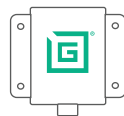

HUB



MOUSE



EXTERNAL MEMORY



Supports RAM® NFC Extender

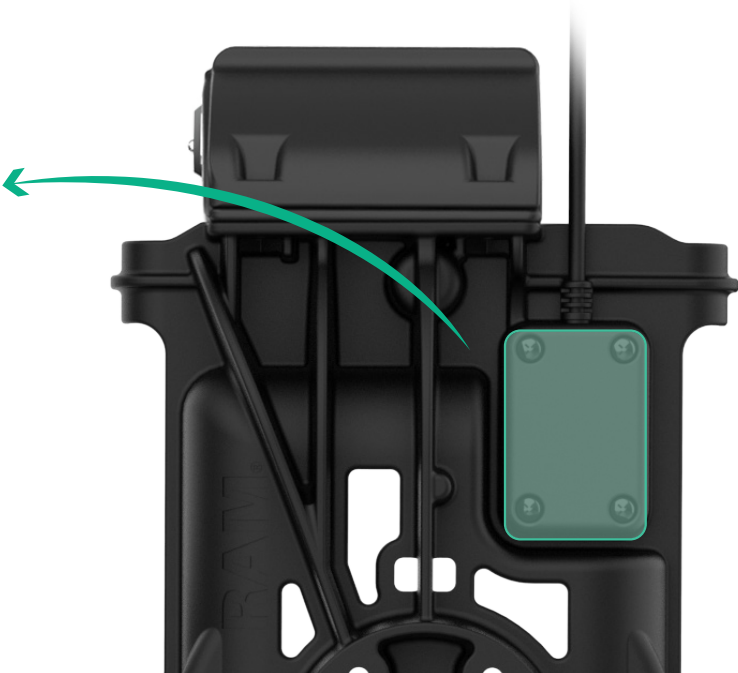



SEEN IN THIS PHOTO:

RAM-GDS-DOCK1-SAM62CPU

Locking GDS® Tough-Dock™ for Tab Active5 & 3

RAM-VENT1-RCT-50U

RAM® Vent-Temp™ with Back Dock Connection for Rectangular Vents

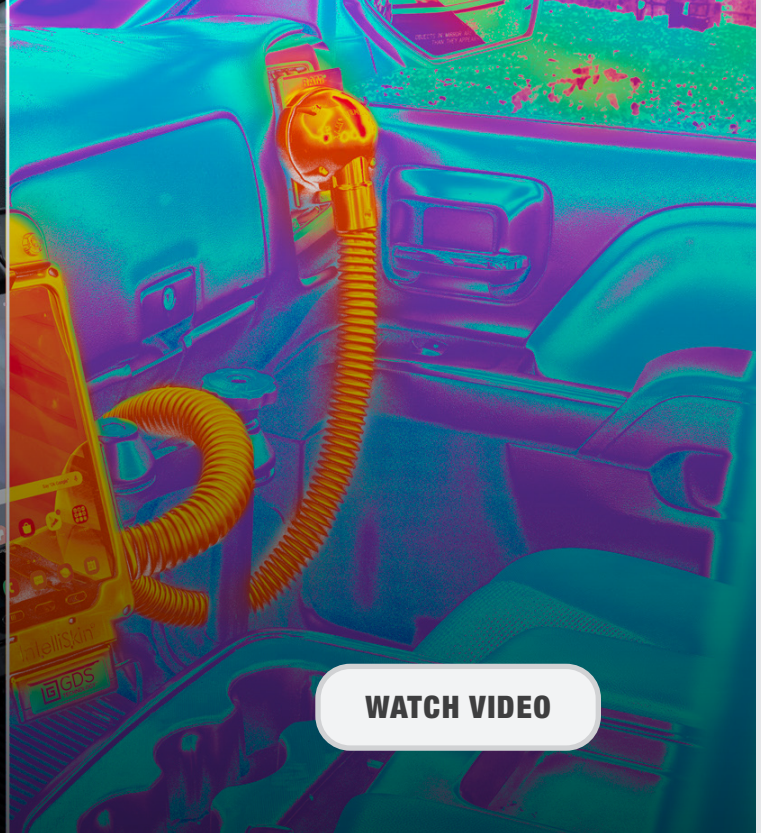

WATCH VIDEO

CONTENTS
HOW IT WORKS
 BRANDS
 MAGNETIC MOUNTING
 FORKLIFT MOUNTING
 YARD & TERMINAL
 MANUFACTURING
 WAREHOUSING
 SHIPPING
 CHARGERS

Temperature Control

Located at the back of your dock is an empty housing for upgrading your mounting solution. This housing can accommodate various temperature modules provided by RAM® Mounts. Easily install either the RAM® Vent-Temp™, which connects to your vehicle's A/C vents or the RAM® Temp-Right™, which provides regulated heat in extremely cold environments.

RAM® VENT-TEMP™ BACK NOZZLE ATTACHMENT

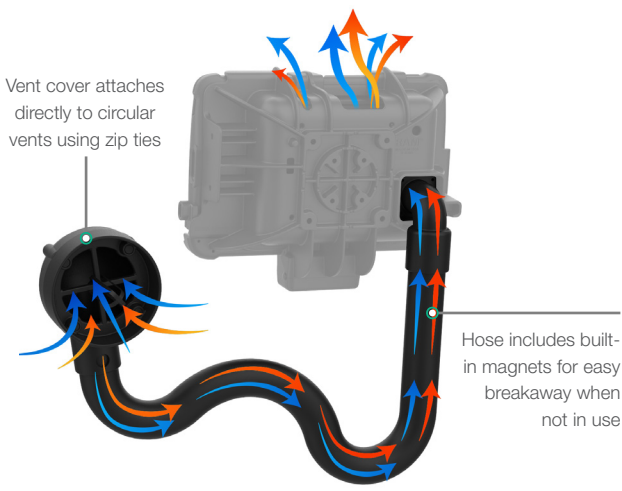

RAM® TEMP-RIGHT™ HEATING MODULE

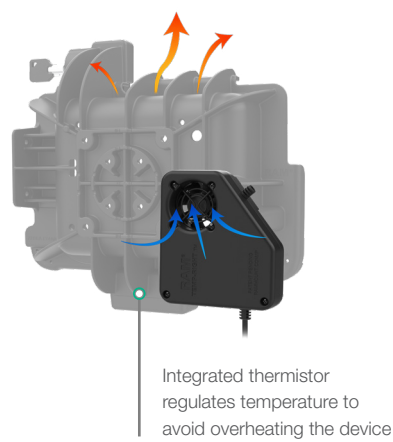



SEEN IN THIS PHOTO

RAM-GDS-HS1MU

GDS® Hand-Stand™ Magnetic Hand
Strap and Kickstand for Tablets

HOW IT WORKS: INTELLISKIN® & GDS® TECH™

GDS® Ergo™

Enable your devices for field use with GDS® Ergo™ accessories. The GDS® Hand-Stand™ is a combination hand strap and kickstand that allows you to take your device from the warehouse to the office—and everywhere in between. With the shoulder strap accessory, quickly attach various IntelliSkin® sleeves to comfortably carry your device.

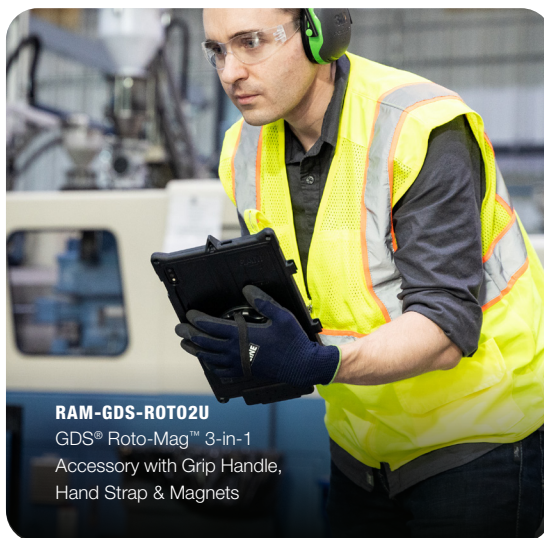

RAM® vs. GDS®

RAM® Docks™

For Closed-Cockpit, Clean, & Calm Environments

While all RAM® products are rugged and reliable, OEM device ports vary in their ability to maintain a clean, reliable connection. With this consideration in mind, mounting a device without an IntelliSkin® is generally recommended in static or closed cockpit environments that are less likely to collect dirt or debris.

DEVICE STAYS DOCKED

Frequent insertion and removal can stress docking contacts, so if you plan to keep your device docked long-term, RAM® Docks are ideal.



LOW-PROFILE VEHICLE DOCKS

RAM® offers low-profile docks for the Samsung Tab Active5, ensuring full functionality while docked.







SMALL SCALE & SHORT TERM

A single RAM® Powered Dock is more cost-effective than a GDS® Dock™ with IntelliSkin®, but upgrading your device might require a new docking station, potentially increasing costs over time.



AVAILABLE FEATURES IN RAM® & GDS®

-  Locking & Non-Locking
-  Single & Dual Peripheral Support
-  Ethernet Connectivity
-  Temp Control Accessories
-  Heated Pogo Pins
-  NFC Extender
-  DB9 Connector





GDS® Docks™

For Open, Dirty, & Harsh Environments

In dirty, rough environments, interrupted device connection is unavoidable. This is mainly due to the lack of cleaning maintenance and excessive debris buildup. The pogo pad contacts on the bottom of the IntelliSkin® are intentionally flat to reduce the debris buildup, making it easy to clean.



DEVICE MOVES FREQUENTLY

IntelliSkin®'s protective pogo pads enable frequent docking and undocking while keeping your device safe, so with GDS® accessories, your team can use and store the device confidently.



VEHICLE, DESKTOP, & MASS CHARGING DOCKS

GDS® Docks™ provide various solutions for moving devices between locations, including the rugged GDS® Tough-Dock™, universal Uni-Conn™, and multiple Desktop Docks.



LARGE SCALE & LONG TERM

GDS® Ecosystem™ costs more upfront than a RAM® dock but offers scalability and better protection, making it a cost-effective long-term investment.



Brands

RAM® Mounts partners with trusted device manufacturers to enable an effective and cost-efficient enterprise workflow with our rugged mounting solutions. From form-fit RAM® docks to the universal GDS® Ecosystem™, learn which brands we support and how you can keep your fleet of devices connected, protected, and charged.

Samsung

[VIEW ALL SAMSUNG SOLUTIONS](#)



Apple

[VIEW ALL APPLE SOLUTIONS](#)



Zebra

[VIEW ALL ZEBRA SOLUTIONS](#)



Getac

[VIEW ALL GETAC SOLUTIONS](#)



Honeywell

[VIEW ALL HONEYWELL SOLUTIONS](#)



NOTE: RAM® Form-Fit Docks are only recommended for closed cockpits or clean environments with infrequent device docking and undocking. For environments with high vibration, dirt, debris, or highly mobile workers who are frequently docking and undocking their devices, IntelliSkin® with GDS® is recommended.

Magnetic Mounts

Quickly move the location of your device mount and opt out of time-consuming installations with our line of heavy-duty magnetic mounting solutions. These bases securely attach to any ferrous surface—popular locations include forklift posts, vehicle sides, machinery, work benches, and more! Explore our recommended bundles for smaller, more compact devices and larger, heavier tablet solutions.

Ball Base



10 MAGNETS N62
Max. Weight - 2lb

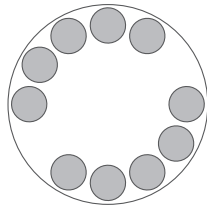

RAM-238-MAG88U

RAM® Tough-Mag™ Magnetic Ball Base

88MM Diameter - C Size

Double Ball Mounts

PAIR WITH ANY HOLDER OR DOCK



RAM-101-MAG88U

RAM® Double Ball Mount with
Round Plate

Medium Arm



RAM-101-B-MAG88U

RAM® Double Ball Mount with
Round Plate

Short Arm



RAM-138-MAG88U

RAM® Double Ball Mount with
Diamond Plate

Medium Arm



RAM-138-B-MAG88U

RAM® Double Ball Mount with
Diamond Plate

Short Arm



SEEN IN THIS PHOTO:

RAP-396-MAG88U
 RAM® Power-Grip™ Scanner Gun Holder
 with Tough-Mag® 88MM Adapter

Adapters



RAM-MAG88DU

RAM® Tough-Mag™ 88MM Adapter with 2-Hole AMPS Pattern
 Connects directly to holder or dock for a low-profile solution



RAP-396-MAG88U

RAM® Power-Grip™ Scanner Gun Holder with
 Tough-Mag® 88MM Adapter

Pivot Mounts



AVAILABLE IN THE FOLLOWING VARIATIONS:

- **Tooth Lock vs. Friction Adjustability**
- **Pivot Styles**
 - Single Pivot
 - Dual Pivot - Straight
 - Dual Pivot - 90°/Perpendicular
- **Knob vs. Barrel Nut**
 - Extension Knob for Ease of Adjustability
 - Barrel Nut for Tamper Resistance
- **Mount Types**
 - Magnetic (using Tough-Mag™ 88MM Adapter)
 - Drill-Down

Forklift Mounts

Sit-Down Forklifts

Using RAM® Mounts, there are a wide range of mounting solutions and mounting locations for forklifts and other equipment in material handling settings. This catalog will help you find compatible mounting systems for overhead guards, square posts, or any location appropriate on a range of equipment beyond forklifts.



1 FLAT SURFACE



MAGNETIC MOUNT

2 VERTICAL POST
SQUARE OPTION



SQUARE POST CLAMP

3 VERTICAL POST
ROUND OPTION



ROUND RAIL CLAMP

4 OVERHEAD GUARD



OVERHEAD GUARD MOUNT

Stand-Up Forklifts



1 FLAT SURFACE

2 VERTICAL POST
SQUARE OPTION

3 CAGE GUARD

4 OVERHEAD GUARD



MAGNETIC MOUNT



SQUARE POST CLAMP



CAGE GUARD MOUNT

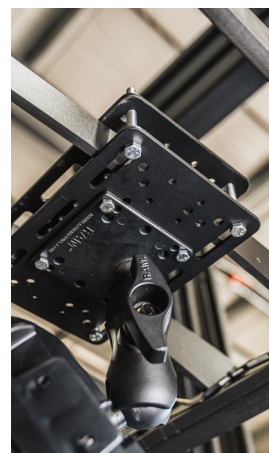

OVERHEAD GUARD MOUNT

FORKLIFT MOUNTS

Bases

Magnetic

**BEST
SELLER**



RAM-238-MAG88U

RAM® Tough-Mag™ Magnetic Ball Base
88MM Diameter - C Size



RAM-202-333-MAG88U

RAM® Tough-Mag™ Double Magnetic Ball Base
C Size



RAM-TRACK-EXA-9B-MAG88U

RAM® Tough-Track™ Magnetic Track System

Square Post Clamp

**BEST
SELLER**



RAM-247U

RAM® Square Post Clamp Base
1.75" - 4" Wide - C Size



RAM-247U-4

RAM® Square Post Clamp Base
Up to 4" Wide - C Size



RAM-D-247U

RAM® Square Post Clamp Base
1.75" - 4" Wide - D Size



RAM-D-247U-4

RAM® Square Post Clamp Base
Up to 4" Wide - D Size



RAM-D-247U-4-IN1

RAM® Steel Reinforced Square Clamp Base
Up to 4" Wide - D Size

Round Rail Clamps



RAM-271U-12
RAM® Rail Clamp Ball Base
1.25" - 1.875" Rails - C Size



RAM-D-271U-12
RAM® Rail Clamp Ball Base
1.25" - 1.875" Rails - D Size



RAM-271U-2
RAM® Rail Clamp Ball Base
2" - 2.5" Rails - C Size



RAM-D-271U-2
RAM® Rail Clamp Ball Base
2" - 2.5" Rails - D Size



RAM-202U-CR01
RAM® Ball Base for Crown Work Assist®
C Size



RAM-D-202U-CR01
RAM® Ball Base for Crown Work Assist®
D Size

Overhead Guard



RAM-335-246
RAM® Lift Truck Overhead Guard Base
with Ball
C Size



RAM-335-D-246
RAM® Lift Truck Overhead Guard Base
with Ball
D Size

Cage Guard



RAM-403BPU
RAM® Low-Profile Cage Mount with
Backing Plate

FORKLIFT MOUNTS
Build Your Bundle

For Rugged Tablets & Vehicle-Mounted Computers



SQUARE POST CLAMP



RAM-D-101U-C-247-4
 RAM® 4" Square Post Clamp Mount with Round AMPS Plate
 4" - D Size

BEST SELLER



RAM-D-2461U-C-247-4
 RAM® Square Post Clamp Mount with 75x75mm VESA Plate
 4" - D Size

Featured Add-Ons

BEST SELLER



RAM-D-247-C-254-DIS1U
 RAM® Universal Forklift Post Mount



RAM-KB2-USB
 GDS® Keyboard™ with Track Pad



RAM-KB4-USB
 GDS® Keyboard™ with 10-Key Numeric Pad



ROUND RAIL CLAMP



RAM-D-254U + RAM-D-201U-C + RAM-D-271U-2
 RAM® Rail Clamp Mount with Round AMPS Plate
 2" - 2.5" Diameter



RAM-D-2461U + RAM-D-201U-C + RAM-D-271U-2
 RAM® Rail Clamp Mount with 75x75mm VESA Plate
 2" - 2.5" Diameter



OVERHEAD GUARD MOUNT



RAM-D-254U + RAM-D-201U-C + RAM-335-D-246
 RAM® Overhead Guard Double Ball Mount with Round AMPS Plate



RAM-D-2461U + RAM-D-201U-C + RAM-335-D-246
 RAM® Overhead Guard Double Ball Mount with 75x75mm VESA Plate

ON-THE-GO DATA TRACKING

For workers needing to input data on-the-go, opt for the forklift bundle featuring this keyboard-ready mounting solution.



For Scanners, Printers, & Handhelds

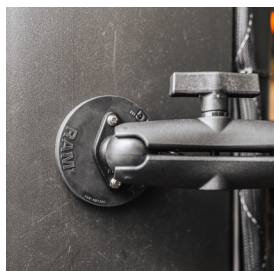

MAGNETIC MOUNT



RAM-101-MAG88U
RAM® Tough-Mag™ Double Ball Mount
C Size - Medium Arm



BEST SELLER



RAM-101U-247
RAM® Universal Post Clamp Mount with Round Plate
C Size - Medium Arm



SQUARE POST CLAMP



RAM-101U-247-4
RAM® Square Post Clamp Mount with Round AMPS Plate
Up to 4" Wide - C Size



ROUND RAIL CLAMP



RAM-103U + RAM-271U-2
RAM® Rail Clamp Mount
2" - 2.5" Diameter



RAM-101U-271-12
RAM® Rail Clamp Mount with Round Plate
1.25" - 1.875" Diameter



RAM-101U-CR01
RAM® Universal Double Ball Mount for Crown Work Assist®
C Size - Medium Arm



OVERHEAD GUARD MOUNT



RAM-103U-D + RAM-335-246
Overhead Guard Double Ball Mount
C Size - Long Arm

Featured Add-Ons



RAP-396U
RAM® Power-Grip™ Scanner Gun Holder



RAP-450U
RAM® Power-Grip™ XL Scanner Gun Holder



YARD & TERMINAL

YARD & TERMINAL

Container Movement

Operators are tasked with keeping pace with the industry's ever-increasing demand. Enable your team to perform with higher precision at faster speeds with a highly curated in-cab experience with top-of-the-line equipment. The RAM® Tough-Mag™ 4-Point Magnetic Mounting Base is the ideal, rugged solution for enclosed cabs.



**RAM-MAG48-4U + RAM-D-101U-C-MI1-2461
+ RAM-HOL-GE5PU**

RAM® Tough-Mag™ 4-Point Magnetic Mount & Powered Dock for Getac ZX80

ADD-ON MOUNTING



Extend your workspace with an attachable side bracket for cable management and mounting small devices.



DRIVER-CENTRIC DESIGN

Form-fit cradle combined with pogo pin technology ensures an effortless docking experience. Charge and connect the ZX80 without the hassle of cords.



SEEN IN THIS PHOTO:

RAM-HOL-ZE25U
RAM® Form-Fit Holder for
Zebra ET6x

RAM-333-224-1U
RAM® Twist-Lock™ Triple
Suction Cup Base

YARD & TERMINAL: CONTAINER MOVEMENT

Ruggedized Hardware Design



HEATING ACCESSORY

When temperatures drop, the self-regulating heater will force hot air through the back of the tablet, bringing the device up to a safe operating temperature.

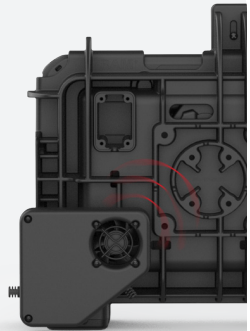

RAM-HOL-HON9PKLU

RAM® Key-Locking Powered Dock for Honeywell RT10 Tablet



SEEN IN THIS PHOTO:

RAM-HOL-GE5PU
 RAM® Form-Fit Powered
 Dock for Getac ZX80

Build Your Bundle

NOTE: We recommend magnetic bases for a rugged, reliable connection to the vertical cab window inside a closed-cockpit environment.



1

RAM-MAG48-4U
 RAM® Tough-Mag™ Magnetic
 Mounting Base

2

RAM-D-101U-C-MI1-2461
 RAM® Double Ball Mount with
 VESA Plate
 D Size - Short Arm

3

RAM-HOL-GE5PU
 RAM® Form-Fit Powered Dock for
 Getac ZX80

YARD & TERMINAL

Digital Check-In & Automated Gates

It's no simple task to maintain a safe and secure yard with the vehicle traffic required for a highly efficient and profitable yard. Keep your device's battery topped up with a GDS® Dock™ and prevent device drops with ergonomic accessories.

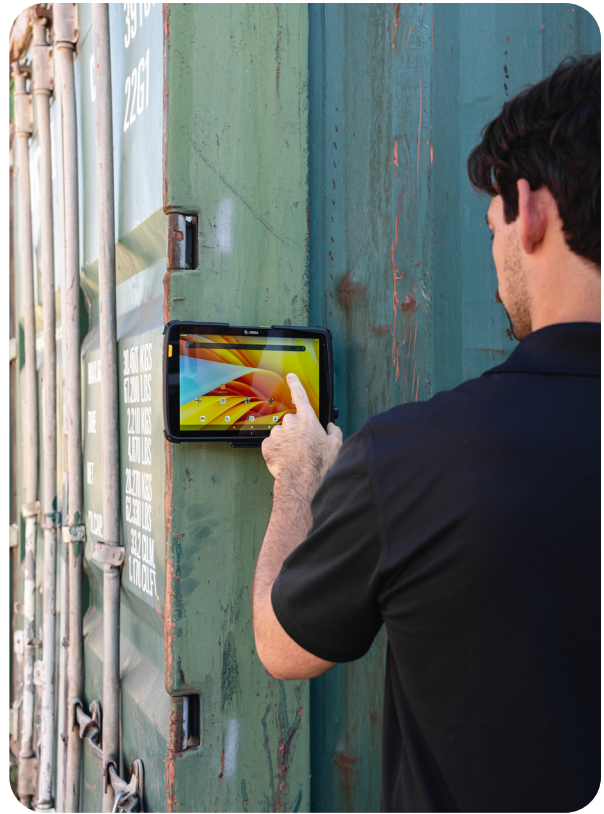

Build Your Bundle



LISTEN FOR THE "CLICK" NOISE

**RAM-GDS-SKIN-SAM54-NG-1 + RAM-GDS-U1AU
+ RAM-GDS-DOCK-D14-U1C-2A**

IntelliSkin® Next Gen for Samsung Tab Active4 Pro with Uni-Conn™
Tilt & Swivel Dock



3-in-1 Roto-Mag™

RAM-GDS-SKIN-ZE21C-NG + RAM-GDS-ROTO2-ZE21U

IntelliSkin® Next Gen for Zebra ET4x 10" with GDS® Roto-Mag™ 3-in-1 Grip
Handle Accessory





YARD & TERMINAL

Dock Management

Enable your team to scan more and scan faster with RAM® Scanner Gun Mounts. Designed for the grab-and-go worker, our scanner gun holders feature an open-top design with rubber prongs for rapid, secure insertion and removal. The open-bottom design allows workers to scan even when docked.



RAP-450U

RAM® Power-Grip™ XL Universal
Scanner Gun Holder



ACCESSIBLE SCANNER

The RAM® Power-Grip™ secures your 2D barcode scanner and features an open bottom design that allows you to quickly scan without removing the device.



SEEN IN THIS PHOTO:

- RAP-450U**
RAM® Power-Grip™ XL Universal Scanner Gun Holder
- RAM-101-B-MAG88U**
RAM® Double Ball Mount with Round Plate - Short Arm

Build Your Bundle

Scanner Gun Holders



RAP-396U
RAM® Power-Grip™ Universal Scanner Gun Holder

BEST SELLER



RAP-450U
RAM® Power-Grip™ XL Universal Scanner Gun Holder



Compatible Mounts



RAM-101U
RAM® Double Ball Mount
C Size - Medium Arm



RAM-101-MAG88U
RAM® Double Ball Magnetic Mount
C Size - Medium Arm



RAP-401-202U
RAM® Tough-Claw™ Large Clamp Double Ball Mount
C Size - Medium Arm



RAM-101U-235
RAM® Double U-Bolt Rail Mount
C Size - Medium Arm



SEEN IN THIS PHOTO

RAM-HOL-SAM60CP-1AU

RAM® EZ-Roll'r™ Power + Data
Dock Samsung Tab Active5 & 3

YARD & TERMINAL
Yard Jockey

From pre-trip inspections to documentation and reporting, your yard jockey's device equipped with fleet management software is a vital part of the equation for a highly efficient and profitable yard. These devices facilitate seamless communication and data collection, ensuring that all aspects of yard management operate smoothly. Keep your driver's devices fully charged and within arm's reach using RAM® powered docks. These docks ensure your team can concentrate on their responsibilities without concerns about battery life, enhancing productivity and effectiveness in your yard operations.



Build Your Bundle



RAM-SKIN-SAM73 + RAM-101-225B2-SAM60CP-V7CU
 RAM® Skin™ for Samsung Tab Active3 & Dashboard Mount



RAM-HOL-ZE24PU + RAM-B-166U
 RAM® Form-Fit Powered Dock for Zebra TC22 & TC27 with Twist-Lock™ Suction Mount

YARD & TERMINAL

Digital Bill of Lading (BOL)

Protect and extend the life of your device with IntelliSkin®, featuring military-grade drop protection and a fumble-free charging experience in fast-paced environments.

**PAIRS SEAMLESSLY WITH
GDS® ERGO™ ACCESSORIES**



Hand Strap



Hand-Stand™



Shoulder Strap



RAM-GDS-SKIN-SAM90-NG
IntelliSkin® Next Gen for Samsung
Tab Active5



RAM-GDS-SKIN-SAM88-NG
IntelliSkin® Next Gen for Samsung
Tab A9+





SEEN IN THIS PHOTO

RAM-GDS-SKIN-AP37-NG
IntelliSkin® Next Gen for Apple iPad Pro
12.9 3rd - 6th Gen & iPad Pro 13

RAM-GDS-ROTO2U
GDS® Roto-Mag™ 3-in-1 Accessory with
Grip Handle, Hand Strap, & Magnets



SEEN IN THIS PHOTO

RAM-GDS-DOCK-6G16P-RJ45
 GDS® 6-Port Power + 6-Port RJ45
 Dock for Tablets with IntelliSkin®

YARD & TERMINAL: DIGITAL BOL



Fits Any IntelliSkin®

6-PORT RJ45 DOCK

Securely push fleet-based software updates to six IntelliSkin®-wrapped tablets during downtime.

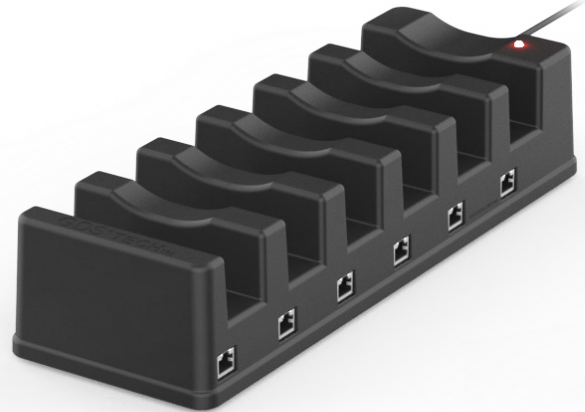

RAM-GDS-DOCK-6G16P-RJ45

GDS® 6-Port Power + 6-Port RJ45 Dock for Tablets with IntelliSkin®

Build Your Bundle

OPTIONAL INSERTS

To accommodate thinner Zebra device models



RAM-GDS-SKIN-ZE34 + RAM-GDS-DOCK-6G15P

IntelliSkin® for Zebra TC53/58 with 6-Port Powered Dock



Hand-Stand™



Shoulder Strap

RAM-GDS-SKIN-SAM88-NG + RAM-GDS-HS1U + RAM-GDS-SS1U

IntelliSkin® Next Gen for Samsung Tab A9+ with Hand-Stand™ & Shoulder Strap



Hand-Stand™



Shoulder Strap

RAM-GDS-SKIN-SAM90-NG + RAM-GDS-HS1U + RAM-GDS-SS1U

IntelliSkin® Next Gen for Samsung Tab Active5 with Hand-Stand™ & Shoulder Strap

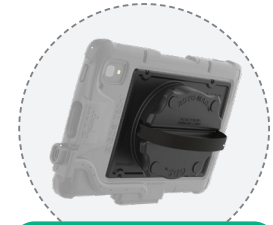

3-in-1 Roto-Mag™



RAM-GDS-SKIN-ZE20C-NG + RAM-GDS-ROTO2-ZE20U

IntelliSkin® Next Gen for Zebra ET4x 8" with GDS® Roto-Mag™ 3-in-1 Grip Handle



MANUFACTURING

MANUFACTURING

Work Order Management

Maintenance and facility workers servicing manufacturing machines can keep their work orders and machine status on hand by pairing IntelliSkin® with the GDS® Roto-Mag™ ergonomic accessory line. The rotating, magnetic hand strap can secure their device to any ferrous surface and is available for tablets from Samsung, Zebra, Apple, and more!



RAM-GDS-SKIN-SAM90-NG

IntelliSkin® Next Gen for Samsung Tab Active5



3-in-1 Roto-Mag™

RAM-GDS-ROT02U

GDS® Roto-Mag™ 3-in-1 Accessory with Grip Handle, Hand Strap, & Magnets



SEEN IN THIS PHOTO

RAM-GDS-DOCK-D7U

GDS® Desktop Dock with Power Delivery - Small Tablets & Phones

MANUFACTURING: INJECTION MOLDING & DIE CAST
Build Your Bundle

PAIRS SEAMLESSLY WITH GDS® ERGO™ ACCESSORIES



RAM-GDS-SKIN-SAM90-NG

IntelliSkin® Next Gen for Samsung Tab Active5



3-in-1 Roto-Mag™

RAM-GDS-ROTO2U

GDS® 3-in-1 Roto-Mag™



Shoulder Strap

RAM-GDS-SS1U

GDS® Shoulder Strap

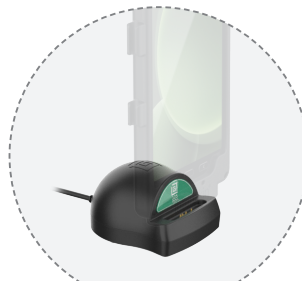

Desktop Dock

RAM-GDS-DOCK-D7U

GDS® Powered Desktop Dock



Desktop Charger

RAM-GDS-DOCK-6G1PD-NGU

GDS® 6-Port Desktop Charger



SEEN IN THIS PHOTO

RAM-GDS-SKIN-SAM90-NG

IntelliSkin® Next Gen for Samsung Tab Active5

RAM-GDS-SS1U

GDS® Shoulder Strap Accessory



SEEN IN THIS PHOTO

RAM-HOL-SAM60CP-1AU

RAM® EZ-Roll'r™ Power + Data Dock
Samsung Tab Active5 & 3

RAM-101U

RAM® Double Ball Mount - C Size Medium

MANUFACTURING Packaging

OPTIMIZE WAREHOUSE EFFICIENCY WITH FIXED-MOUNT DEVICES

Wearable or fixed-mount devices play a crucial role in optimizing operations within packing and staging areas. By facilitating the automation of high-volume processes, these devices significantly minimize the need for manual inspections. This leads to enhanced productivity and improved accuracy, allowing workers to focus on more complex tasks while ensuring that quality standards are consistently met.



RAM-HOL-ZE21PD2NLLU

RAM® Tough-Dock™ Power + Dual USB for Zebra ET4x 10" Tablet



RAM-HOL-SAM60CP-1AU

RAM® EZ-Roll'r™ Power + Data Dock Samsung Tab Active5 & 3



SEEN IN THIS PHOTO:

RAM-HOL-ZE21PKLU
 Locking RAM® Tough-Dock™ for Zebra ET4x 10" Tablet

Build Your Bundle

Docks



RAM-SKIN-SAM91
+ RAM-HOL-SAM60CP-2AU
 RAM® Skin™ for Samsung Tab Active5 with Dual USB Powered Dock



RAM-HOL-ZE21PD2NLLU
 RAM® Tough-Dock™ Power + Dual USB for Zebra ET4x 10"



Compatible Mounts



RAM-101U
 RAM® Double Ball Mount
C Size - Medium Arm



RAM-101U-D
 RAM® Double Ball Mount
C Size - Long Arm



RAP-401-202U
 RAM® Tough-Claw™ Large Clamp Double Ball Mount
1" - 2.2" Diameter



RAM-238-MAG88U + RAM-103U
 RAM® Tough-Mag™ Double Ball Mount
C Size - Medium Arm



SEEN IN THIS PHOTO

RAM-GDS-SKIN-SAM88-NG

IntelliSkin® Next Gen for Samsung
Tab A9+

MANUFACTURING

Quality Inspection

Maintain a thorough quality assurance process by pairing the IntelliSkin with the GDS® Magentic Hand-Stand™ —ideal for mobile workers whose workflow demands they go hands-free and safely place their device on top of surfaces or magnetized to any ferrous surfaces.



Build Your Bundle



Hand-Stand™



Hand-Stand™

RAM-GDS-SKIN-SAM88-NG + RAM-GDS-HS1MU

IntelliSkin® Next Gen for Samsung Tab A9+ with GDS® Hand-Stand™

RAM-GDS-SKIN-AP37-NG + RAM-GDS-HS1MU

IntelliSkin® Next Gen for iPad Pro 12.9 3rd - 6th Gen & iPad Pro 13 (M4) with GDS® Hand-Stand™



MANUFACTURING Time Clocks

Maintain a highly versatile time clock solution with GDS® Uni-Conn™. The rear pogo pads on the IntelliSkin® Thin-Case™ make sanitization easy while keeping your device charged and directly connected to ethernet. The quick-release wall docks enable supervisors to easily grab the tablet and go mobile. Consider upgrading to the locking docks for theft deterrence and peace of mind.

Build Your Bundle



INTELLISKIN® THIN-CASE™ WITH REAR POGO PADS

Available for Tab Active5 & 3, iPad Air 11", & iPad 10th Gen

Compatible Wall Docks

**REAR POGO PADS PROVIDE
CONVENIENT ACCESS FOR
EASY CLEANING**



**GET A FASTER, MORE SECURE
NETWORK CONNECTION WITH
POWER OVER ETHERNET (POE)**



RAM-GDS-DOCKLR-U3CPU + RAP-403FU

GDS® Uni-Conn™ Locking Snap-In Dock
with Low-Profile Mounting Plate



RAM-GDS-DOCK-W4-POEU

GDS® Uni-Conn™ Powered Wall Dock
with PoE



SEEN IN THIS PHOTO

RAM-GDS-SKIN-SAM93-TCB
 IntelliSkin® Thin-Case™ for Tab Active5 & 3
 (Rear Pogo Pads)

RAM-GDS-DOCKLR-U3CPU
 GDS® Uni-Conn™ Powered Right Locking
 Snap-In Dock with USB-C Connector

RAP-403FU
 RAM® Spacer Plate Accessory for Flush
 Mounting

Leave for victims of domestic violence and their family members from work for legal or law enforcement counseling, relocation, medical protection, relocation, medical safety accommodations to visit wages/leave.
 Leave for military spouses Spouses or registered domestic partners of active or reserve military personnel on military duty may take a total of 12 weeks of unpaid leave. Your employer may not fire a spouse or registered domestic partner for taking leave or protected leave.
 PUBLICATION F700-074-0

EM
EMPL

The Employee Protection Act detector tests employees for prohibited substances.

PROHIBITIONS

EXEMPTIONS

EXAMINEE RIGHTS

ENFORCEMENT

You may be eligible for UNEMPLOYMENT BENEFITS if you lose your job.

Visit www.esd.wa.gov and click "Sign in or create account"

- CONTENTS
- HOW IT WORKS
- BRANDS
- MAGNETIC MOUNTING
- FORKLIFT MOUNTING
- YARD & TERMINAL
- MANUFACTURING**
- WAREHOUSING
- SHIPPING
- CHARGERS



WARNING
Read and understand
operator's manual before
using the machine.
Failure to follow operating
instructions could result
in death or serious injury.

PRECAUTION
Do not touch the
rotating parts.
Do not touch the
hot parts.
Do not touch the
moving parts.
Do not touch the
electrical parts.



SIGMA



SEEN IN THIS PHOTO:

RAM-HOL-ZE26PU
RAM® Powered Dock for Zebra TC8300

RAM-101-MAG88U
RAM® Double Ball Magnetic Mount

MANUFACTURING

Assembly Line

Cut device loss off at the source and protect your assembly line scanner guns with the RAM® Power-Grip™ holder and RAM® Powered dock. Ideal for fast-paced environments with lots of moving parts, this holder provides a secure home base for scanners while ensuring they stay accessible so your team can stay highly mobile and productive.



ACCESSIBLE SCANNER

The RAM® Power-Grip™ secures your 2D barcode scanner and features an open bottom design that allows you to quickly scan without removing the device.

Build Your Bundle

Scanner Gun Holder and Dock

Magnetic Mount



RAP-450U
RAM® Power-Grip™ XL
Scanner Gun Holder



RAM-HOL-ZE26PU
RAM® Powered Dock for
Zebra TC8300



RAM-HOL-ZE32PU
RAM® Powered Dock for
Zebra MC9400 & MC9300



RAM-101-B-MAG88U
RAM® Double Ball
Magnetic Mount
B Size - Short Arm

SEEN IN THIS PHOTO

RAM-GDS-SKIN-ZE21C-NG

IntelliSkin® Next Gen for Zebra ET4x 10" Enterprise Tablet

RAM-GDS-ROTO2-ZE21U

GDS® Roto-Mag™ 3-in-1 Grip Handle Accessory for Zebra ET4x 10" Tablet



MANUFACTURING

Maintenance

Keep your maintenance team highly mobile and hands-free with GDS® Ergo™ accessories.

Build Your Bundle



3-in-1 Roto-Mag™



Shoulder Strap



STREAMLINED CHARGING

Simplify your setup with one charging cord for multiple devices and accelerated power with GDS® Technology™



RAM-GDS-SKIN-ZE21C-NG + RAM-GDS-ROTO2-ZE21U + RAM-GDS-SS1U

IntelliSkin® Next Gen for Zebra ET4x 10 with GDS® Roto-Mag™ & Shoulder Strap

RAM-GDS-DOCK-6G16P

GDS® 6-Port Powered Dock for Tablets with IntelliSkin®



WOLFRAM
MANUFACTURING
TECHNOLOGIES

Wolfram Manufacturing Implements Solutions for Future-Ready Operations

Wolfram Manufacturing, a 30,000-square-foot machine shop in Austin, Texas, specializes in high-volume metal part production using its own advanced technology. In addition to running a full production shop, they offer CNC machine monitoring software and Caron Engineering products like TMAC to optimize machine shops.

Wolfram approached RAM® Mounts to develop solutions for two monitoring systems: machine performance and horsepower. Both required heavy-duty monitors and fixed tablets with adjustable viewing angles, as the existing hardware lacked flexibility. RAM® Mounts solved the issue by integrating robust drill-down double ball mounts with VESA plated adapters and iPad mini 6 EZ-Roll'r™ cradles. This setup enhanced access and flexibility, enabling operators to efficiently implement the new monitoring systems.

[Read the Full Story](#)



RAM-B-101U-C + RAM-HOL-AP36U
RAM® EZ-Roll'r™ Cradle for Apple iPad mini 6
with Universal Double Ball Mount
B Size - Long Arm



SEEN IN THIS PHOTO

RAM-B-101U-C

RAM® Universal Double Ball Mount with Two Round Plates - B Size Long Arm

RAM-HOL-AP36U

RAM® EZ-Roll'r™ Cradle for Apple iPad mini 6



119201



WAREHOUSING

WAREHOUSING Forklift

Distracted driving causes accidents. Keep your team's hands free and on the steering wheel while they operate heavy machinery with help from RAM® Mounts. Our forklift solutions keep the devices in view without obstructing the driver's field of vision.



EASILY PRIORITIZE WAREHOUSE SAFETY STANDARDS

RAM® Mounts makes it easier to comply with local, federal, and international forklift safety standards to keep your workers safe while on the job.

**RAM-335 + RAM-D-101-C-254U + RAM-DIS-103-2AU
+ RAM-GDS-DOCK-SAM54NCDU + RAM-101U + RAM-KB2-USB**
GDS® Overhead Guard Bundle with Keyboard for Samsung Tab
Active4 Pro

WAREHOUSING: FORKLIFT Build Your Bundle

Inertia Bundle



RAM-GDS-SKIN-SAM54-NG-1
+ **RAM-GDS-DOCK-SAM54NC-CU**

IntelliSkin® Next Gen for Samsung Tab Active4 Pro with Dual USB GDS® Tough-Dock™



RAM-KB2-USB

GDS® Keyboard™ with Track Pad



RAM-D-247-C-254-DIS1U

RAM® Universal Forklift Post Mount with Round Plate & Accessory Option



Scanner Gun Kit



ACCESSIBLE SCANNER

The open bottom design allows for easy scanning without removing the device.



RAP-450U + RAM-101U-247

RAM® Power-Grip™ XL Scanner Gun Holder with Universal Post Clamp Mount





WAREHOUSING: FORKLIFT BUNDLES
Printer Mount



RAM-PM1-ZE31U + RAM-D-101U-C-247-4
RAM® 4" Square Post Printer Mount with Paper Feed for Zebra ZQ630 Series



Handheld PC



RAM-GDS-SKIN-ZE34 + RAM-GDS-DOCK-V12-ZE2434CPU
IntelliSkin® for Zebra TC53/58 with GDS® Powered Dock



RAM-102U-B-247
RAM® Universal Post Clamp Mount
C Size - Short Arm



SEEN IN THIS PHOTO

RAM-GDS-SKIN-SAM54-NG-1

IntelliSkin® Next Gen for Samsung Tab Active4 Pro & Tab Active Pro

RAM-GDS-DOCK-SAM54NCD2U

GDS® Tough-Dock™ + Dual USB for Samsung Tab Active4 Pro & Tab Active Pro

RAM-DIS-103-2AU

RAM® Standard Heavy Duty Accessory/Display Bracket

RAM-KB2-USB

GDS® Keyboard™ with Track Pad

RAM-101U

RAM® Double Ball Mount with Two Round Plates - C Size Medium



Georgia-Pacific Keeps One Eye on Tomorrow

Georgia-Pacific is one of the world's leading manufacturers of paper and forest products. Since 1927, they have been growing, expanding, and perfecting the art of life's simple necessities. With over 150 facilities & 30,000 people directly employed, they rely on a cohesive technology ecosystem to keep their business running smoothly. So when they outgrew their Microsoft ecosystem, they knew it was time to invest in a custom solution from Samsung, Zebra, & Abetech that would scale alongside them.

After deciding on Samsung's Tab Active product line, Zebra's Ultra-Rugged Scanners, & Abetech's Mobile Device Management software, they reached out to 3Eye & RAM® to keep their new devices safe both physically and financially with a future-proof solution.

Read the Full Story



RAM-GDS-DOCK-SAM54NCD2U
GDS® Tough-Dock™ + Dual USB for Samsung Tab Active4 Pro & Tab Active Pro



SEEN IN THIS PHOTO

RAM-HOL-ZE24U

RAM® Form-Fit Holder for Zebra TC22 & TC27 with Boot

RAM-202-404U

RAM® Tough-Claw™ Medium Clamp Double Ball Mount with Round Plate

WAREHOUSING

Order Picking

OPTIMIZE ORDER EFFICIENCY WITH MOUNTED DEVICES

Wearable or fixed-mount devices help workers in order picking areas streamline high-volume processes, reducing manual inspection time and enhancing efficiency.

MODULAR TOP CUP

The spring-loaded top cup allows for easy one-handed removal of the device.



RAM-HOL-ZE24PU

RAM® Form-Fit Powered Dock for Zebra TC22 & TC27 with Boot

RAM-HOL-TAB-SAM29U

RAM® Tab-Tite™ Holder for Samsung Tab Active5 & 3





SEEN IN THIS PHOTO

RAM-HOL-ZE24U

RAM® Form-Fit Holder for Zebra TC22 & TC27 with Boot

RAM-202-404U

RAM® Tough-Claw™ Medium Clamp Double Ball Mount with Round Plate

WAREHOUSING: ORDER PICKING

Build Your Bundle

Phone & Universal



RAM-B-400-C-UN10U

RAM® X-Grip® Large Phone Mount
with Tough-Claw™ Small Clamp Base
B Size - Long Arm



Scanner Gun



RAP-450U + RAM-103U-B + RAP-404U

RAM® Power-Grip™ Scanner Gun Holder with
Tough-Claw™ Mount



Handheld PC

Tablet



RAM-HOL-ZE7-NP-2U + RAM-B-238-MAG88U + RAM-B-103-C-238U
 RAM® Form-Fit Holder for Zebra TC70, 72, 75 & 77
 with Tough-Mag™ Mount

RAM-HOL-TAB-SAM29U + RAM-202-404U
 RAM® Tab-Tite™ Holder for Samsung Tab Active5 & 3
 with Tough-Claw™ Mount





SEEN IN THIS PHOTO

RAM-HOL-HON12U

RAM® Spring-Loaded Holder for
Honeywell CT40/45/47

RAM-202-404U

RAM® Tough-Claw™ Medium Clamp
Double Ball Mount with Round Plate

WAREHOUSING

Pallet Jacks & Carts

Don't let expensive devices get tossed to the side during the picking process—protect your investment with a hands-free docking solution that ensures the device screen remains visible at all times.

SECURE, ONE-HANDED SOLUTIONS FOR A STREAMLINED WAREHOUSE



RAM-HOL-H0N12U

RAM® Spring-Loaded Holder for Honeywell
CT40/45/47



RAM-HOL-ZE17-NP-2U

RAM® Form-Fit Dock for Zebra TC53 & TC58



SEEN IN THIS PHOTO

RAM-HOL-ZE32PDU

RAM® Powered Dock + Single USB-A
for Zebra MC9400 & MC9300

WAREHOUSING: PALLET JACKS & CARTS



SEAMLESS SCANNING

Opening in the top cup
allows for easy scanning
while device is docked



RAM-HOL-ZE32U

RAM® Spring-Loaded Holder for Zebra MC9400 & MC9300



RAM-HOL-ZE9U

RAM® Quick-Draw™ Form-Fit Holder for Zebra TC8000/8300

Build Your Bundle

Holders



RAM-HOL-HON12U

RAM® Spring-Loaded Holder for Honeywell CT40/45/47



RAM-HOL-HON7NPU

RAM® Form-Fit Holder for Honeywell CT50, CT60, & CT60 XP



RAM-HOL-ZE9U

RAM® Quick-Draw™ Form-Fit Holder for Zebra TC8000/8300



RAM-HOL-ZE32U

RAM® Spring-Loaded Holder for Zebra MC9400 & MC9300



RAM-HOL-ZE17-NP-2U + RAM-101-MAG88U

RAM® Form-Fit Dock for Zebra TC53 & TC58 with Tough-Mag™ Mount

Compatible Mounts



RAP-401-202U

RAM® Tough-Claw™ Large Clamp Double Ball Mount with Round Plate

C Size - Medium Arm



RAM-202-400

RAM® Tough-Claw™ Small Clamp Mount with Round Plate Adapter

C Size - Medium Arm



RAM-202-404U

RAM® Tough-Claw™ Medium Clamp Double Ball Mount with Round Plate

C Size - Medium Arm



RAM-101U-235

RAM® Double U-Bolt Rail Mount

C Size - Medium Arm



RAM-101-MAG88U

RAM® Double Ball Mount with Round Plate

C Size - Medium Arm



SEEN IN THIS PHOTO

RAM-GDS-SKIN-SAM54-NG-1
IntelliSkin® Next Gen for Samsung
Tab Active4 Pro & Tab Active Pro

RAM-GDS-HS1U
GDS® Hand-Stand™ Hand Strap
and Kickstand for Tablets

RAM-GDS-SS1U
GDS® Shoulder Strap Accessory

WAREHOUSING Management

Equip your management team with essential tools for warehouse efficiency, including security cameras, mobile tablets with ergonomic accessories, and mass charging solutions for device inventory management. These resources enable managers to oversee operations effectively and address challenges as they arise.



RAM-101U-D-240

RAM® Double Ball Mount with Large Round Plates

C Size - Long Arm





Hand-Stand™

RAM-GDS-HS1U
GDS® Hand-Stand™ Hand Strap and Kickstand for Tablets



Build Your Bundle

Tablet



Hand-Stand™



Shoulder Strap

RAM-GDS-SKIN-SAM54-NG-1 + RAM-GDS-HS1U + RAM-GDS-SS1U
IntelliSkin® Next Gen for Samsung Tab Active4 Pro with Hand-Stand™ & Shoulder Strap



RAM-GDS-DOCK-6G16P
GDS® 6-Port Powered Dock for Tablets with IntelliSkin®



SHIPPING





SEEN IN THIS PHOTO

RAM-HOL-ZE31U

RAM® Quick Release Printer Holder for Zebra ZQ630 Series

RAM-101-MAG88U

Double Ball Mount with Round Plate - Medium Arm

SHIPPING

Bill of Lading (BOL)

Provide your mobile printers with a secure home base for when they're not in use or not on the go. RAM® mounting solutions are fully adjustable so you can position your printer exactly how, and where, you want them.

ON-THE-GO ACCESS

Quick-release latch ensures mobility for on-the-go workers





SHIPPING: BOL

Build Your Bundle Printer Holders



RAM-HOL-ZE31U

RAM® Printer Mount for Zebra ZQ630 Series



RAM-HOL-ZE30U

RAM® Printer Mount for Zebra ZQ521 Series



RAM-HOL-ZE29U

RAM® Printer Mount for Zebra ZQ511 Series



RAM-HOL-ZE27U

RAM® Printer Mount for Zebra ZQ320 Series



RAM-HOL-ZE28U

RAM® Printer Mount for Zebra ZQ310 Series



RAM-VPR-104

RAM® Quick-Draw™ Jr. Universal Small Printer Holder



RAM-PM1-ZE31U

RAM® Printer Mount with Paper Feed for Zebra ZQ630 Series

SEEN IN THIS PHOTO

RAM-PM1-ZE31U

RAM® Printer Mount with Paper Feed for Zebra ZQ630 Series

RAM-D-101U-C-247-4

RAM® 4" Square Post Clamp Mount with Round AMPS Plate - D Size

RAM-101U-B

RAM® Universal Double Ball Mount with Two Round Plates - C Size Short

RAP-396U

RAM® Power-Grip™ Universal Scanner Gun Holder

Compatible Mounts



RAM-101U

RAM® Double Ball Mount with Two Round Plates
C Size - Medium Arm



RAM-101U-D

RAM® Double Ball Mount with Two Round Plates
C Size - Long Arm



RAP-401-202U

RAM® Tough-Claw™ Large Clamp Double Ball Mount with Round Plate
C Size - Medium Arm



RAM-101U-247-4

RAM® 4" Square Post Clamp Mount with Round AMPS Plate
C Size - Medium Arm





SHIPPING

Pallet Management

Seamlessly scan, wrap, and track your pallets from your pallet wrapper with the assistance of the RAM® Mounts magnetic track solution. This versatile bundle can be upgraded or downgraded to fit your shipping department's needs.

Build Your Bundle

Pallet Wrapper Bundle

1

RAM-HOL-SAM52CPU

RAM® USB-C Powered Dock for Samsung Tab Active4 Pro & Tab Active Pro

2

2X RAM-103U

RAM® Double Socket Arm with Round Ball Plate
C Size - Medium Arm

3

2X RAM-463-TRA1U

RAM® Aluminum Track Ball Base with T-Bolt Attachment
C Size

4

RAM-TRACK-EXA-9B-MAG88U

RAM® Tough-Track™ with Tough-Mag™ Heavy Duty Magnetic Track System

5

RAP-450U

RAM® Power-Grip™ XL Universal Scanner Gun Holder



QUICK INSTALLATION

Easily mount to any ferrous surface with Tough-Mag™ bases



SHIPPING: PALLET MANAGEMENT BUNDLES

RAM® X-Grip® Kit



1

RAM-B-MAG66U

RAM® Tough-Mag™ Magnetic Ball Base
66MM Diameter

2

RAM-B-201U

RAM® Double Socket Arm
B Size - Medium

3

RAM-HOL-UN7BU

RAM® X-Grip® Universal Phone Holder with Ball
B Size

QUICK INSTALATION

Easily mount to any ferrous surface with Tough-Mag™ bases

MINIMIZE DOWNTIME

By securely holding devices and allowing for quick adjustments, the RAM® X-Grip® reduces downtime in shipping areas to ensure seamless operation and accessibility.





HARDWIRE CHARGERS



HARDWIRE CHARGERS

Wiring Diagram

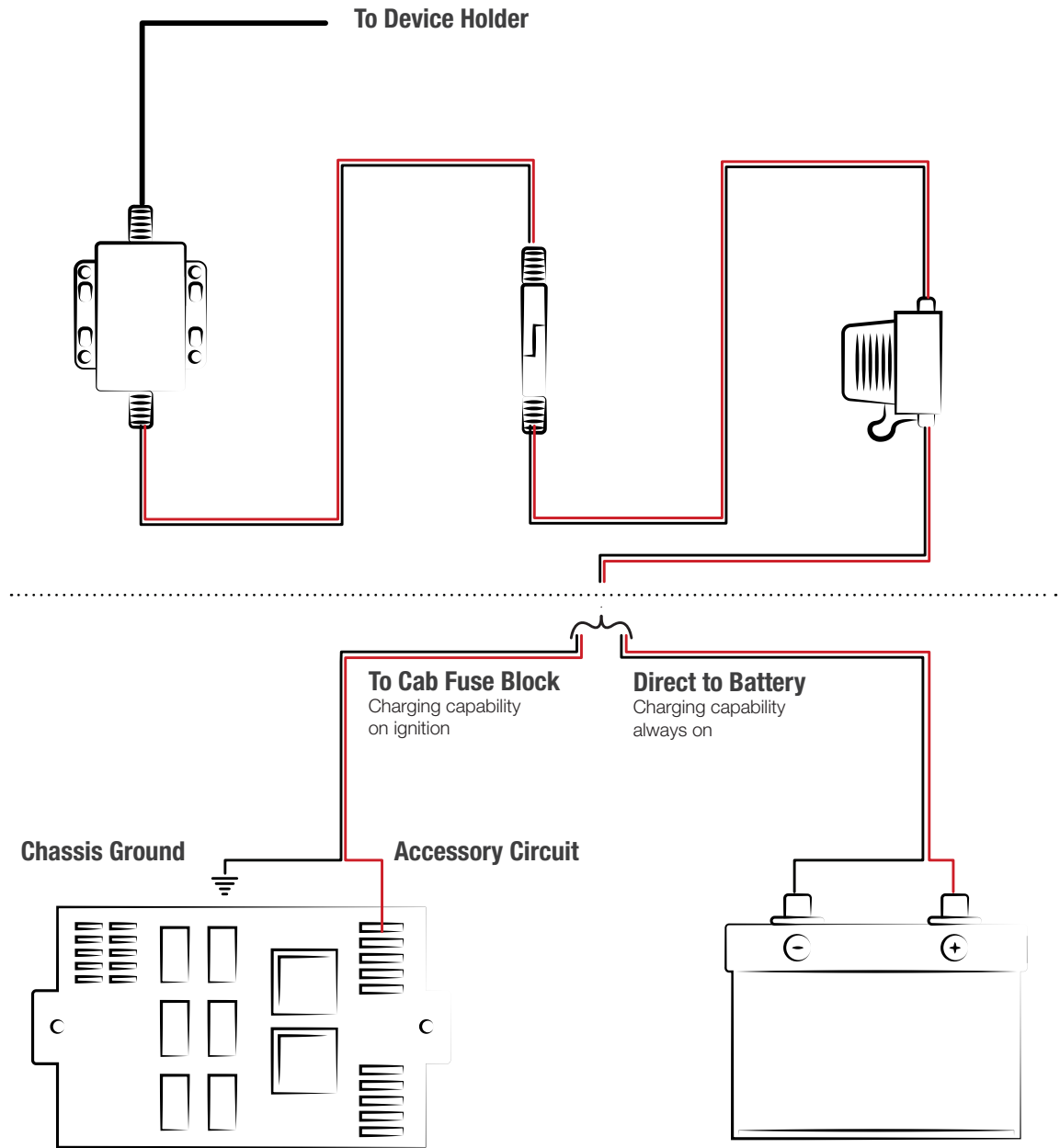



HARDWIRE CHARGERS

Compatibility Charts



USB-A Female



USB-C Male



DC 5.5mm Male

USB-A Female Chargers

FOR DOCKS WITH USB-A MALE CONNECTORS

PART ID	INPUT VOLTAGE	OUTPUT VOLTAGE
RAM-GDS-CHARGE-V7B1U	10-30VDC TRUCKS, PROPANE FORKLIFTS	5-9VDC @ 2.5A
RAM-GDS-CHARGE-V8BU	30-64VDC ELECTRIC FORKLIFTS	5-9VDC @ 2.5A

USB-C Male Chargers

FOR DOCKS WITH USB-C FEMALE CONNECTORS

PART ID	INPUT VOLTAGE	OUTPUT VOLTAGE
RAM-GDS-CHARGE-V7CU	10-30VDC TRUCKS, PROPANE FORKLIFTS	5.42-9VDC @ 2.5A LEGACY DEVICES
RAM-GDS-CHARGE-V3C-2U	10-30VDC TRUCKS, PROPANE FORKLIFTS	5-15VDC @ 3A POWER DELIVERY DEVICES
RAM-GDS-CHARGE-V8CU	30-64VDC ELECTRIC FORKLIFTS	5.42-9VDC @ 2.5A LEGACY DEVICES
RAM-GDS-CHARGE-V3CH-2U	30-64VDC ELECTRIC FORKLIFTS	5-15VDC @ 3A POWER DELIVERY DEVICES

DC 5.5mm Male Chargers

FOR DOCKS WITH 5.5MM DC FEMALE CONNECTORS

PART ID	INPUT VOLTAGE	OUTPUT VOLTAGE	COMPATIBLE DEVICES
RAM-GDS-CHARGE-V17U	10-32VDC	9VDC @ 3.5A	Zebra MC9400 & MC9300
RAM-GDS-CHARGE-V18U	24-64VDC	9VDC @ 3.5A	Zebra MC9400 & MC9300
RAM-GDS-CHARGE-V9U	20-60VDC	12VDC @ 3.5A	Honeywell RT10, Honeywell ScanPal EDA10A, Zebra ET5x, Zebra ET4x, Zebra ET8x, Zebra ET6x, Zebra ZQ630
RAM-GDS-CHARGE-V10-1U	10-32VDC	12VDC @ 3.5A	Honeywell RT10, Honeywell ScanPal EDA10A, Zebra ET5x, Zebra ET4x, Zebra ET8x, Zebra ET6x, Zebra ZQ630
RAM-GDS-CHARGE-V10U	10-32VDC	12VDC @ 3.5A	Getac ZX70
RAM-GDS-CHARGE-V14U	10-28VDC	16VDC @ 3.5A	Panasonic FZ-A3
RAM-GDS-CHARGE-V15U	28-60VDC	16VDC @ 3.5A	Panasonic FZ-A3
RAM-GDS-CHARGE-V11U	10-32VDC	19VDC @ 3.5A	Getac ZX10, Zebra L10
RAM-GDS-CHARGE-V12U	24-60VDC	19VDC @ 3.5A	Getac ZX10, Zebra L10
RAM-GDS-CHARGE-V19U	10-32VDC	14VDC @ 3.5A	Getac ZX80
RAM-GDS-CHARGE-V20U	20-60VDC	14VDC @ 3.5A	Getac ZX80



About RAM® Mounts

RAM® Mounts manufactures rugged and versatile mounting systems for phones, tablets, and other mobile devices that can be attached nearly anywhere. Unlike other mounts on the market, RAM® allows you to secure devices where you need them most. The unique design of the RAM® Mounts system provides quick installation, adjustability, strength, vibration damping, and durability—all at a low cost. Backed by a lifetime warranty, RAM® uses powder-coated, marine-grade aluminum with lightweight and high-strength composites, stainless steel hardware, and rubber balls.

THE RAM® DIFFERENCE



PREMIUM DESIGN

The rubber ball and socket design of our mounting systems offers a secure hold, with near-infinite adjustability and vibration damping for the most demanding environments. With thousands of components trusted by users around the world, we've been able to design and develop mounting solutions that consumers and companies previously only dreamed were possible.



CUSTOMIZABLE

Take your phone mount from your truck to your boat, or mix and match components to create your ideal mount. Because of the modularity of the RAM® system, you can customize your solution to fit your specific needs in almost any application.

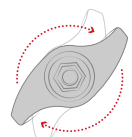

QUALITY MATERIALS

A premium design deserves the highest quality materials available, from rubber and stainless steel to high-strength composites and marine-grade aluminum. Our facilities— including powder coating, die casting, rubber injection molding, and shock and vibration testing—help us deliver on this promise to bring you inventive mounting solutions.

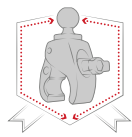

LIFETIME WARRANTY

It's simple. Our reputation as the leader of premier mounting systems means if we build it, then we guarantee it. We're confident in the quality of our products, and with our warranty, you can be too.

*1-3 year warranty on electronics, including powered docks

NATIONAL PRODUCTS INC. (NPI)

Introduced in 1990, National Products Inc. (NPI) quickly became the leading manufacturer of rugged and versatile mounting solutions. RAM® Mounts has grown to offer approximately 5,000 modular components—the most innovative product line of its kind for nearly any application and device, including phones, tablets, GPS systems, laptops, marine electronics, printers, radios, and much more.

In addition to RAM® Mounts, NPI is also the creator of award-winning IntelliSkin® sleeves and GDS® Technology™ products. IntelliSkin® sleeves ruggedize a wide range of consumer phones and tablets, while the GDS® Ecosystem™ provides users the ability to securely charge, dock, and sync devices in the most demanding environments.

NPI is proudly located in Seattle, Washington in the same neighborhood where the company was started.

PARTNER WITH RAM® MOUNTS

Here at RAM® Mounts, we believe that unfathomable things are possible with ingenuity. With a portfolio of more than 5,000 SKUs paired with innovative engineers and in-house product experts, we have the tools and expertise needed to create solutions that you didn't know were possible. We have the ability to solve your mounting challenges quickly, efficiently, and cost effectively.



Mount Anything, Anywhere.

rammount.com
1.800.497.7479
sales@rammount.com



GDS®, IntelliSkin®, GDS® Tech™, GDS® Technology™, GDS® Green™, Distinctive "Double Delta" Shape™, One Dock to Connect Them All™, GDS® Uni-Conn™, and GDS® Compatible™ are trademarks or registered trademarks of National Products Inc.

The distinctive D Shape™ of the GDS® connector is a trademark of National Products Inc.

PATENTS AND TRADEMARKS
WWW.RAMMOUNT.COM/IP



RAM® double socket arms with their distinctive Hourglass Shape are recognized globally as a symbol of the reliability, quality, and durability of this line of products. The Hourglass Shape is a registered trademark of National Products Inc.



The distinctive RAM® X-Grip® product shape is a trademark of National Products Inc.



Look for the highly recognizable "Double Delta" trademark, the symbol of quality and reliability.