



**RAM[®]
MOUNTS**

On-Water



TABLE OF CONTENTS

3 ABOUT RAM® MOUNTS

5 HOW IT WORKS

- 5 Boating Mounts
 - 7 Kayak Mounts
-

9 BOATING MOUNTS

- 10 Featured Products
 - 11 Rigging Map for Boats
 - 13 Fishfinder Mounts
 - 18 RAM ROD®
-

19 KAYAK MOUNTS

- 20 Featured Products
- 21 Rigging Map for Kayaks
- 23 Fishfinder Mounts
- 28 Adapt-a-Post™ Bases
- 29 RAM ROD®
- 32 Transducer Mounts



33 DEVICE MOUNTS

- 34 Featured Products
 - 35 Phone Mounts
 - 41 Tablet Mounts
 - 43 Camera Mounts
 - 47 GPS & Radio Mounts
-

49 ACCESSORIES & MORE

- 49 Fishfinder Mount Accessories
 - 51 Paddleboard & Inflatable Craft Mounts
 - 52 Drink & Paddle Holders
 - 53 RAM® Tough-Track™
 - 56 Trolling Motor Stabilizers
 - 58 Security Mounts
 - 60 Spotlight Mounts
-

61 COMPATIBILITY CHARTS

- 62 Kayaking Fishfinder Compatibility
- 63 Boating Fishfinder Compatibility
- 65 Fishfinder Mounts
- 67 Fishing Rod Holders
- 68 RAM® Post & Spline Components
- 69 Transducer Mounts
- 69 RAM® Tough-Pole™ Camera Mounts
- 69 Inflatable Boat & Raft Bases
- 70 RAM® Tough-Track™ & Hand-Track™



ABOUT RAM® MOUNTS

RAM® Mounts manufactures rugged and versatile mounting systems for cameras, tablets, and other mobile devices that can be attached nearly anywhere. Unlike other mounts on the market, RAM® allows you to secure devices where you need them most. The unique design of the RAM® Mounts system provides quick installation, adjustability, strength, vibration damping, and durability—all at a low cost. Backed by a lifetime warranty, RAM® uses powder-coated, marine-grade aluminum with lightweight and high-strength composites, stainless steel hardware, and rubber balls.

THE RAM® DIFFERENCE

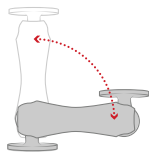

PREMIUM DESIGN

The rubber ball and socket design of our mounting systems offers a secure hold, with near-infinite adjustability and vibration damping for the most demanding environments. With thousands of components trusted by users around the world, we've been able to design and develop mounting solutions that consumers and companies previously only dreamed were possible.

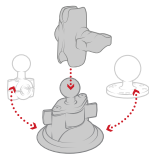

CUSTOMIZABLE

Take your phone mount from your truck to your boat, or mix and match components to create your ideal mount. Because of the modularity of the RAM® system, you can customize your solution to fit your specific needs in almost any application.

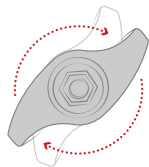

QUALITY MATERIALS

A premium design deserves the highest quality materials available, from rubber and stainless steel to high-strength composites and marine-grade aluminum. Our facilities— including powder coating, die casting, rubber injection molding, and shock and vibration testing—help us deliver on this promise to bring you inventive mounting solutions.

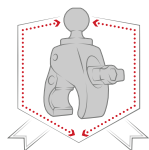

LIFETIME WARRANTY

It's simple. Our reputation as the leader of premier mounting systems means if we build it, then we guarantee it. We're confident in the quality of our products, and with our warranty, you can be too.



NATIONAL PRODUCTS INC. (NPI)

Introduced in 1995, National Products Inc. (NPI) quickly became the leading manufacturer of rugged and versatile mounting solutions. RAM® Mounts has grown to offer approximately 5,000 modular components—the most innovative product line of its kind for nearly any application and device, including phones, tablets, GPS systems, laptops, marine electronics, printers, radios, and much more.

In addition to RAM® Mounts, NPI is also the creator of award-winning IntelliSkin® sleeves and GDS® Technology™ products. IntelliSkin® sleeves ruggedize a wide range of consumer phones and tablets, while the GDS® Ecosystem™ provides users the ability to securely charge, dock, and sync devices in the most demanding environments.

NPI is proudly located in Seattle, Washington in the same neighborhood where the company was started.

PARTNER WITH RAM® MOUNTS

Here at RAM® Mounts, we believe that unfathomable things are possible with ingenuity. With a portfolio of more than 5,000 SKUs paired with innovative engineers and in-house product experts, we have the tools and expertise needed to create solutions that you didn't know were possible. We have the ability to solve your mounting challenges quickly, efficiently, and cost effectively.



HOW IT WORKS

BUILD YOUR KIT WITH THE
RAM® MOUNT BUILDER

BOATING MOUNTS DOUBLE BALL MOUNTS

Out on the water, we know that the ideal experience requires having the versatility to confidently place and adjust your fishfinders and other devices to any position while maintaining the structure of the mount out on harsh waters. Our ball and socket technology allows for near-infinite adjustability while providing the holding power to support heavy devices in any environment. Simply attach the ball adapter to your device and connect with the correct size socket arm to place on to the mounting base in the location of your choosing.

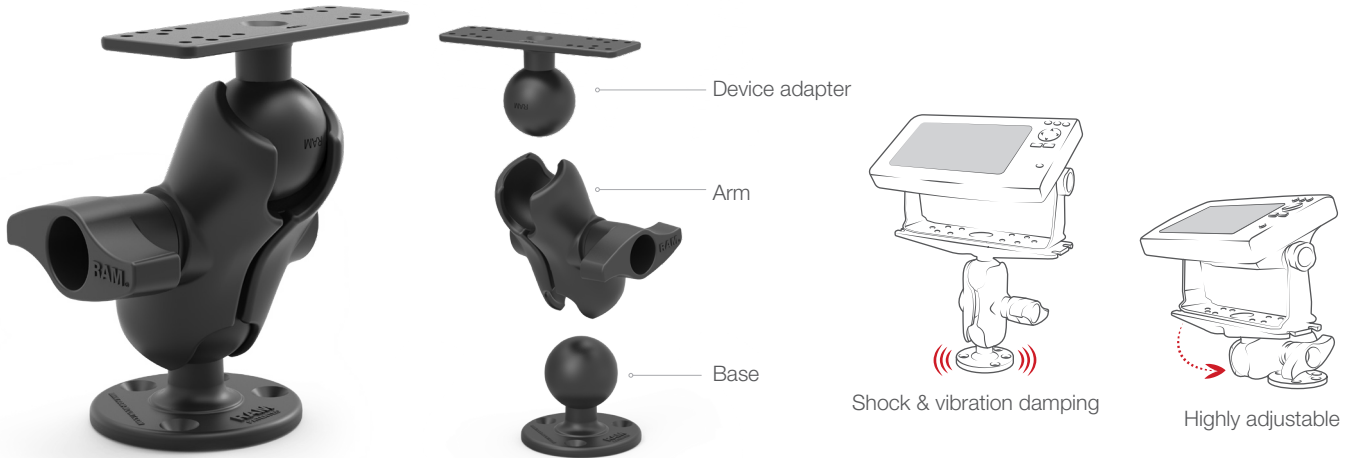

GENERAL RULE

Different sizes of ball and socket mounts are intended for different weight capacities and device sizes. For boats in heavy duty environments, RAM® recommends C size mounts for 4”-7” fishfinders and plotters, and D size mounts for 8”-16” fishfinders and plotters. Swing arm mounts with no ball components can support any size fishfinder or plotter.

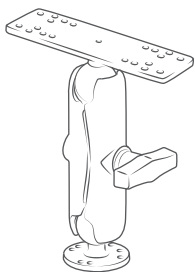

C Size 1.5” Ball Mounts
Holds up to 4 lbs
4”-7” Fishfinders & Plotters

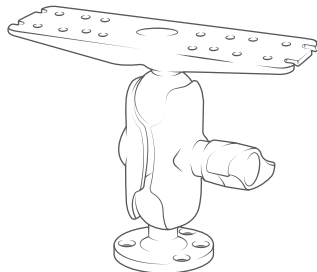

D Size 2.25” Ball Mounts
Holds up to 6 lbs
8”-16” Fishfinders & Plotters

AVAILABLE IN



SWING ARM MOUNTS

For those who desire the simple stability to adjust of your device on the X-axis, our swing arm mounts support 360° horizontal rotations—available with single and double pivot points for dual-articulation. Simply attach your device to the adapter plate, similar to double mount setups, and secure the swing arm mount to the vessel for an easy 2-step installation. Our swing arm mounts can also be mounted on a horizontal or vertical flat surface for a wide range of compatible mounting locations.

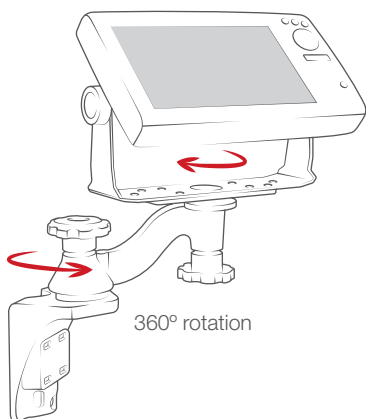

AVAILABLE IN



Single & double swing arm extensions



Horizontal & vertical mounting



Locking accessories



HOW IT WORKS

BUILD YOUR KIT WITH THE
RAM® MOUNT BUILDER

KAYAKING MOUNTS DOUBLE BALL MOUNTS

Space can become limited in a kayak, especially when you factor in the space you can take up with many devices, fish containers, fishing rods, paddles, snacks and more—that's why RAM® Mounts designs the most versatile and rugged mounts on the market so you can feel confident your device is secure. Our ball and socket technology allows for near-infinite adjustability while providing the holding power to support heavy devices in the harshest environments—simply attach the ball adapter to your device and connect with the correct size socket arm to place on to the mounting base in the location of your choosing.

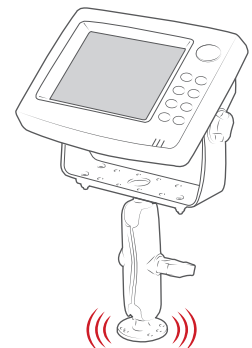

Shock & vibration damping

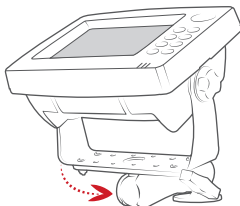

Highly adjustable

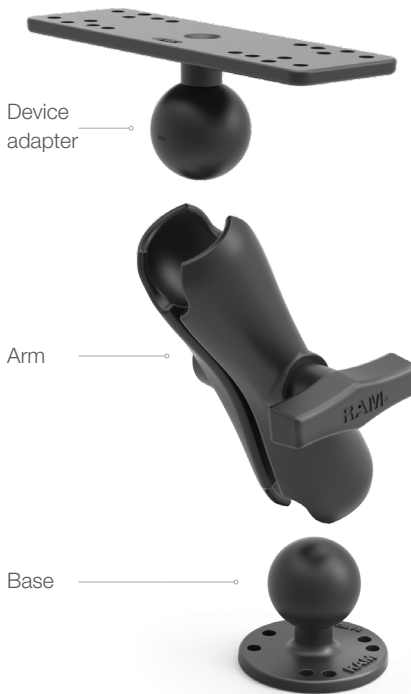

GENERAL RULE

Different sizes of ball and socket mounts are intended for different weight capacities and device sizes. For kayaks, RAM® recommends B size mounts for up to 5" fishfinders and plotters and C size mounts for up to 9" fishfinders and plotters. Drill-down, track mounting, and interchangeable components are available in both B size and C size.

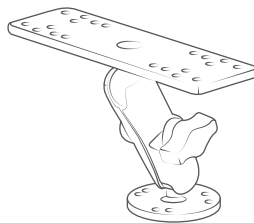

B Size 1" Ball Mounts
Holds up to 2 lbs
4" - 5" Fishfinders & Plotters

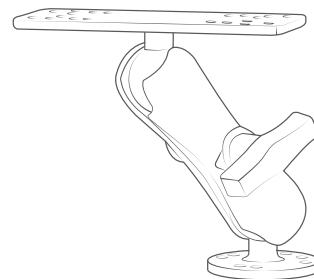

C Size 1.5" Ball Mounts
Holds up to 4 lbs
Up to 9" Fishfinders & Plotters

SEEN IN THIS PHOTO:
RAM-D-115-C
RAM® Universal Marine
Electronic Mount



BOATING MOUNTS

FEATURED PRODUCTS

When it comes to the boating market, no one makes ruggedized mounts capable of holding your expensive fishfinders and fishing rods better than RAM® Mounts. See below for our most popular mounting solutions for both fishing and recreational boats. Explore all the boating mounts we have to offer for fishfinders, rod holders, and more throughout this section.



RAM-D-115-C
D Size, 6.25" x 2" Plate, Short Arm



RAM-D-111U-C
D Size, 11" x 3" Plate, Short Arm



RAM-111U
C Size, 6.25" x 2" Plate, Medium Arm



RAM-109HU
Horizontal, Single Swing Arm



RAM-D-202-25-C-202-KN0B9HU
For Humminbird Helix 8-15, Solix & Apex



RAM-101-G4
For Garmin echo, ECHOMAP & More



RAP-114-421
RAM ROD® Holder with Dual T-Bolt Track Base



RAM-114-BMP
RAM ROD® Holder with Combo Bulkhead Base



RAP-394-SSBMPU
RAM® Tough-Tube™ Holder with Combo Bulkhead Base



RAP-434-421
RAM ROD® JR Fishing Rod Holder with Dual T-Bolt Track Base



RAP-433-BMP
RAM ROD® HD Fishing Rod Holder with Combo Bulkhead Base



RAP-400-202U
RAM® Tough-Claw™ Trolling Motor Stabilizer



RIGGING MAP FOR BOATS

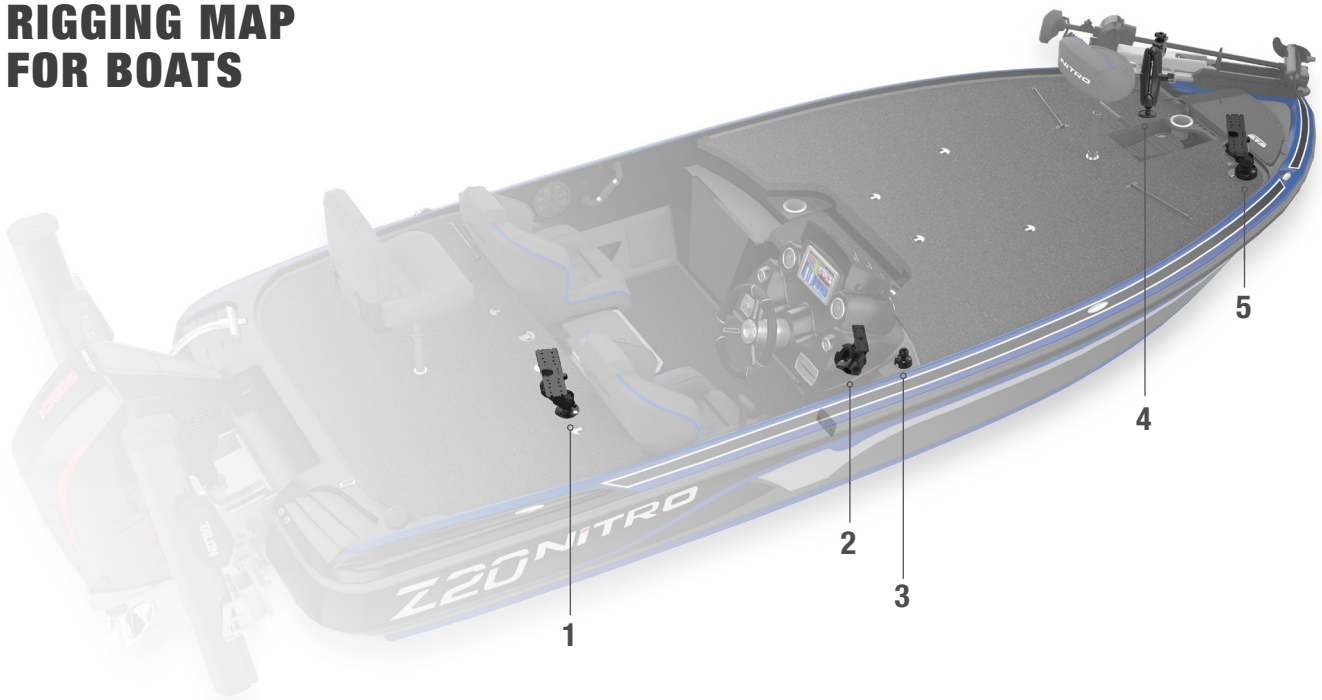

1

RAM-D-111-C
RAM® Large Marine Electronics Mount



2

RAM-D-115-C
RAM® Universal Marine Electronic Mount



3

RAM-202 + RAP-403
C Size Ball Base with
Cable Manager



4

RAM-108U
RAM® Trolling Motor Stabilizer
with Strap Hose Clamp - Medium



5

RAM-D-111U-C
RAM® Large Marine
Electronics Mount

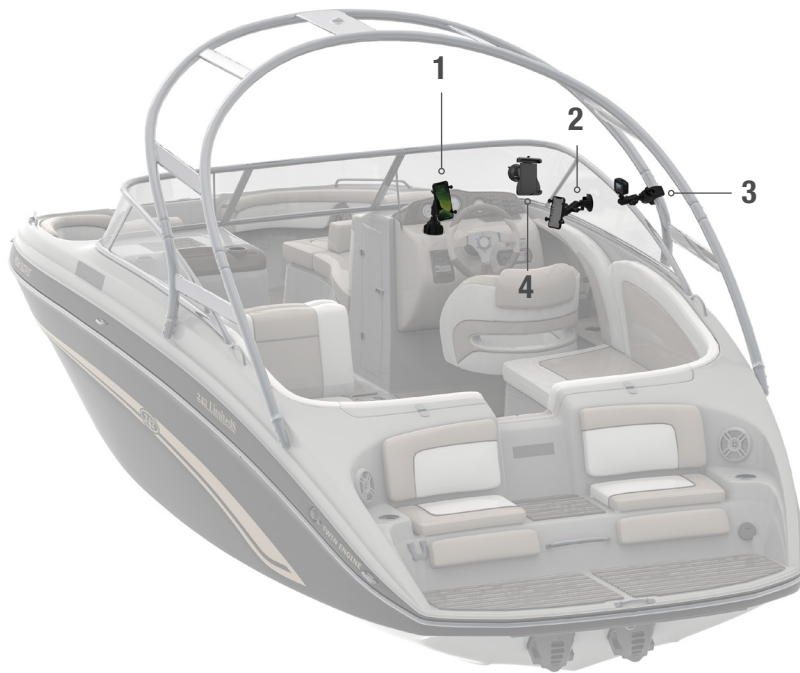

1

RAP-B-299-4-UN10U

RAM® X-Grip® Large Phone Mount with RAM® Stubby™ Cup Holder Base



2

RAM-B-166-UN7

RAM® X-Grip® Phone Mount with RAM® Twist-Lock™ Suction Cup



3

RAP-B-404-GOP1U

RAM® Tough-Claw™ Double Ball Mount with Universal Action Camera Adapter



4

RAM-B-166-UN15WU

RAM® Quick-Grip™ Suction Cup Mount for for iPhone 12 Series + MagSafe

FISHFINDER MOUNTS

“111” SERIES

C Size Ball Mounts for Select 4”-7” Fishfinders & Plotters



RAM-111BU
6.25" x 2" Plate

**BEST
SELLER**



RAM-111U
Drill-Down Kit, Overall Height 7.35"



RAM-S-111U
Drill-Down Pin-Lock™ Security Kit



RAM-111-403U
Drill-Down Kit with Cable Manager



RAM-111B-354-TRA1U
RAM® Track Ball™ Kit

[EXPLORE “111” SERIES KITS](#)

“D-115” SERIES

D Size Ball Mounts for Select 8”-16” Fishfinders & Plotters



RAM-D-115BU
6.25" x 2" Plate

**BEST
SELLER**



RAM-D-115-C
Drill-Down Kit, Overall Height 7.325"



RAM-D-115-C-KNOB9H
Drill-Down Kit with Hi-Torq™ Wrench



RAM-D-115
Drill-Down Kit, Overall Height 10.7"



RAM-D-115-E
Drill-Down Kit, Overall Height 15.2"

[EXPLORE “D-115” SERIES KITS](#)



FISHFINDER MOUNTS CONTINUED

“D-111” SERIES

D Size Ball Mounts for Select 8”-16” Fishfinders & Plotters



RAM-D-111BU
11” x 3” Plate

**BEST
SELLER**



RAM-D-111U-C
Short Arm, Overall Height 8.125”



RAM-D-111U
Drill-Down Kit, Overall Height 11.5”



RAM-D-111-KNOB9HU
Drill-Down Kit with Hi-Torq™ Wrench

[EXPLORE “D-111” SERIES KITS](#)

“109” SERIES

Horizontal & Vertical Swing Arm Mounts



RAM-109VU
Vertical Swing Arm Mount



RAM-109HSB
Horizontal Swing Arm Ball & Socket Mount*

**BEST
SELLER**



RAM-109HU
Horizontal Swing Arm Mount



RAM-109V-1U
Vertical Double Swing Arm Mount



RAM-109H-2U
Horizontal Swing Arm Ball & Socket Mount*

[EXPLORE “109” SERIES KITS](#)



*Ball and socket swing arm mounts are only recommend for up to 7” fishfinders & plotters



[SEE PAGE 63 FOR BOATING FISHFINDER COMPATIBILITY](#)

SEEN IN THIS PHOTO:

RAM-101-G4
RAM® Double Ball Mount with
Garmin Fishfinder Hardware



CUSTOM MOUNTS



[EXPLORE GARMIN KITS](#)

Drill-down mounts for select Striker, echo & ECHOMAP Series



RAM-101-G4
Marine-Grade Aluminum

RAP-101U-G4
High-Strength Composite



[EXPLORE LOWRANCE KITS](#)

Drill-down mounts for select Hook² & Reveal 5 Series



RAM-101-L012
Marine-Grade Aluminum

RAP-101-L012
High-Strength Composite

Drill-down mounts for select Elite & HOOK Series



RAM-101-L011
Marine-Grade Aluminum

RAP-101U-L011
High-Strength Composite



[EXPLORE HUMMINBIRD KITS](#)

Drill-down mounts for Helix 5



RAM-202-153-202U
Marine-Grade Aluminum

RAP-202-153-202
High-Strength Composite

Drill-down mounts for Helix 8-10 & Solix 10



RAM-D-202-25-C-202U
Marine-Grade Aluminum

Drill-down mounts for Helix 8-15, Solix & Apex



RAM-D-202-25-C-202-KNOB9HU
Marine-Grade Aluminum



SEE PAGE 63 FOR **BOATING FISHFINDER COMPATIBILITY**

SEEN IN THIS PHOTO:

RAM-114-NBU

RAM ROD® Fishing Rod Holder with
6" Spline Post

RAP-B-GOP2-A-GOP1U

RAM® Ball Adapter for GoPro® Bases

DID YOU KNOW

The RAM ROD® HD can function as a tube style holder, by positioning the holder vertically, and snapping the bottom arm stop into place.







RAM ROD® HOLDER MOUNTS

BOATING

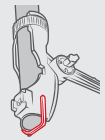

With popular rod holder product lines like the RAM ROD® and RAM® Tube™ series, anglers have trusted RAM® out on the water for years. The high-strength materials, user-friendly design, and modularity are what set our rod holders apart from the competition. Choose a complete fishing rod holder kit, or select your preferred mounting base and pair it with the rod holder that best suits your fishing needs.

RAM ROD® HD FEATURES

-  Fits spinning reels and baitcasters
-  Optional GoPro® mounting point
-  Converts to tube style holder



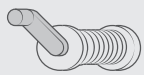



RAM ROD® FEATURES

-  Fits spinning reels and baitcasters
-  Locking latch for added security
-  One-handed insertion & removal



RAM® TOUGH-TUBE™ FEATURES

-  Secure and durable tube design
-  Rotate up to 180°
-  Internal flange prevents spinning of rod



POPULAR MOUNTS



RAP-394-SSBMPU
RAM® Tough-Tube™ with
Combo Bulkhead Base



RAP-433-PA-411
RAM ROD® HD with
Track-Node™ Base



RAM-114-FU
RAM ROD® with Flush Base



RAM-114-BU
RAM ROD® with Bulkhead Base



SEEN IN THIS PHOTO:

RAP-AAP-162U

RAM® Adapt-A-Post™ with Flush Rod Wedge Adapter

RAP-114-APB2U

RAM® Adapt-A-Post™ with Adjustable 13.5" Extension Arm

RAM-114-NBU

RAM ROD® Fishing Rod Holder with 6" Spline Post



KAYAK MOUNTS

FEATURED PRODUCTS

Carefully crafted to elevate the fishing experience of anglers all over the world, RAM® Mounts designs lightweight, durable solutions that do not encroach on the limited space available in your kayak. See below for our most popular mounting solutions for both fishing kayaks and recreational. Explore all the kayaking mounts we have to offer for fishfinders, rod holders, transducers, and more throughout this section.



RAM-B-111U
B Size, 6.25" x 2" Plate



RAM-111U
C Size, 6.25" x 2" Plate



RAM-B-LO12-354-TRA1
Supports Lowrance Hook² & Reveal Series



RAP-434-421
RAM ROD® JR Fishing Rod Holder with Dual T-Bolt Track Base



RAP-433-BMP
RAM ROD® HD Fishing Rod Holder with Combo Bulkhead Base



RAP-394-SSBMPU
RAM® Tough-Tube™ Holder with Combo Bulkhead Base



RAP-114-421
RAM ROD® Holder with Dual T-Bolt Track Base



RAP-390-RB-TRA1U
RAM® Tube Jr.™ with RAM® Track Ball™ Base



RAM-B-316-18-TRA1-TRA1U
RAM® Track Ball™ Transducer Mount



RIGGING MAP FOR KAYAKS

Using RAM® mounting solutions, there are countless ways to customize your kayak using tracks and bases to secure your fishfinder, fishing rod, action camera, and much more. This map provides inspiration with a recommended example of a common rigging scenario.

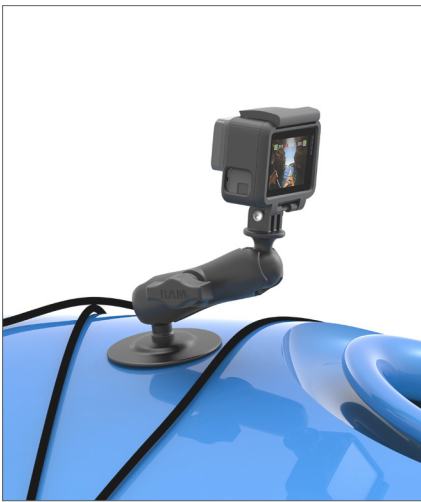
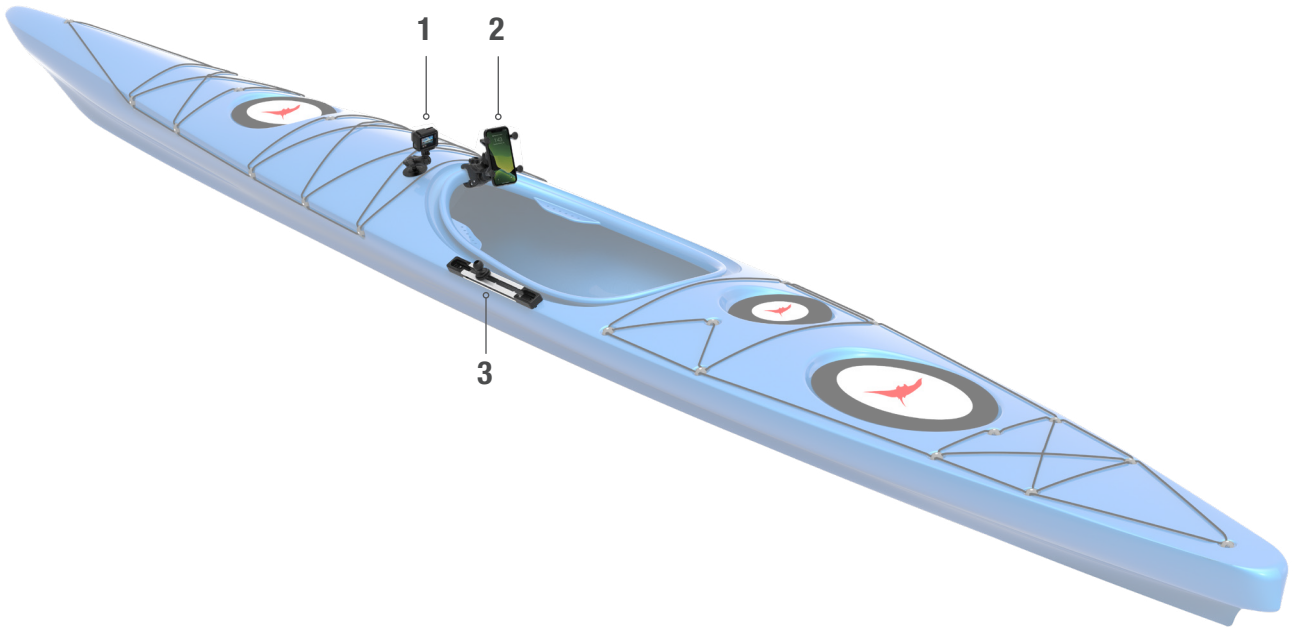

1
RAP-B-378-202U-GOP1
 RAM® Flex Adhesive Double Ball Mount with Action Camera Adapter



2
RAM-B-400-A-HOL-UN7BU
 RAM® X-Grip® Phone Mount with RAM® Tough-Claw™ Small Clamp Base

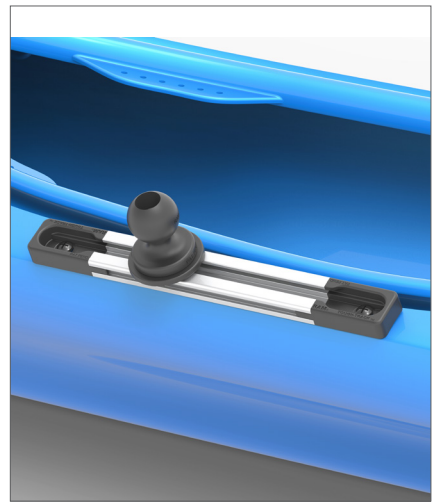

3
RAM-TRACK-EXA-5U
RAP-B-354U-TRA1
 5" Modular Aluminum RAM® Tough-Track™ RAM® Track Ball™ with T-Bolt Attachment

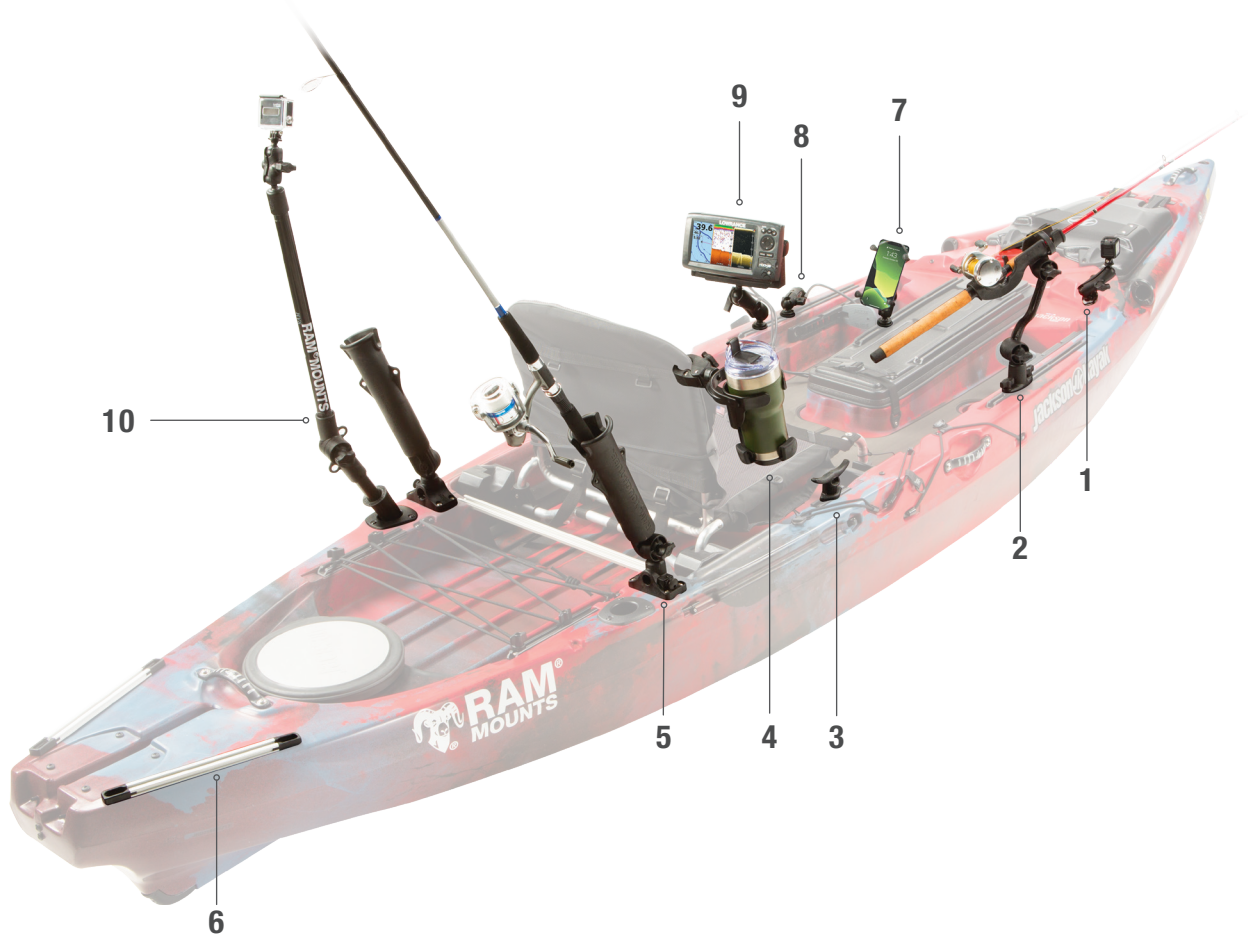

1
Ball Adapter for GoPro®
pg. 44



2
RAM ROD® Holder
pg. 29



3
RAM® Tough-Cleat™
pg. 58



4
RAM® Level Cup™ XL
pg. 52



5
RAM® Tough-Tube™
Rod Holder
pg. 30



6
RAM® Tough-Track™
pg. 53



7
RAM® X-Grip®
Phone Mount
pg. 35



8
Transducer Mount
pg. 32



9
Fishfinder Mounts
pg. 23



10
RAM® Tough-Pole™
Camera Mount
pg. 46

FISHFINDER MOUNTS

“B-111” SERIES

B Size Ball Mounts for Select
4”-5” Fishfinders & Plotters



RAM-B-111BU
6.25” x 2” Plate



RAM-B-111U-A
Drill-Down Kit, Overall Height 3.75”

**BEST
SELLER**



RAM-B-111U
Drill-Down Kit, Overall Height 5”



RAM-S-B-111U
Drill-Down Pin-Lock™ Security Kit



RAP-B-111-A
High-Strength Composite, Drill-Down Kit



RAP-B-111B-354-TRA1U
High-Strength Composite, RAM® Track Ball™ Kit

EXPLORE “111” SERIES KITS



SEEN IN THIS PHOTO:

RAM-B-111U

RAM® Universal Marine
Electronic Mount

FISHFINDER MOUNTS CONTINUED

“111” SERIES
C Size Ball Mounts for Select
4”-7” Fishfinders & Plotters



RAM-111BU
6.25" x 2" Plate

**BEST
SELLER**



RAM-111U
Drill-Down Kit, Overall Height 7.35"



RAM-S-111U
Drill-Down Pin-Lock™ Security Kit



RAM-111-403U
Drill-Down Kit with Cable Manager



RAM-111B-354-TRA1U
RAM® Track Ball™ Kit



RAP-111-B
High-Strength Composite, Drill-Down Kit



RAP-111U
High-Strength Composite, Drill Down Kit

[EXPLORE “111” SERIES KITS](#)



SEEN IN THIS PHOTO:

RAM-111B-354-TRA1U
RAM® Track Ball™ Marine
Electronic Mount

SEEN IN THIS PHOTO:

RAM-B-L012-354-TRA1

RAM® Track Ball™ Double Ball Mount for Lowrance Hook² & Reveal Series



FISHFINDER MOUNTS CONTINUED

CUSTOM MOUNTS



[EXPLORE GARMIN KITS](#)

Drill-down mounts for select Striker, echo & ECHOMAP Series



RAM-B-101-G4
Marine-Grade Aluminum

RAP-B-101U-G4
High-Strength Composite



[EXPLORE LOWRANCE KITS](#)

Drill-down and Track Ball™ mounts for Hook Reveal 5 Series



RAM-B-101-L012
Marine-Grade Aluminum

RAP-B-101-L012
High-Strength Composite

RAM-B-L012-354-TRA1
RAM® Track Ball™ Kit



[EXPLORE RAYMARINE KITS](#)

Drill-down and Tough-Claw™ mounts for select Dragonfly Series



RAM-B-202-379-M616U
Marine-Grade Aluminum &
High-Strength Composite

RAM-B-400-379-M616U
RAM® Tough-Claw™ Kit



SEEN IN THIS PHOTO:

RAP-B-202-153-354-TRA1U

RAM® Track Ball™ Mount for Humminbird Helix 5



FISHFINDER MOUNTS / CUSTOM MOUNTS CONTINUED



EXPLORE HUMMINBIRD KITS

Drill-down and Track Ball™ mounts for Helix 5



RAM-202-153-202U
Marine-Grade Aluminum

RAP-202-153-202
High-Strength Composite

RAP-B-202-153-354-TRA1U
RAM® Track Ball™ Kit

Drill-down and Track Ball™ mounts for Helix 7



RAM-202-24-202U
Marine-Grade Aluminum

RAM-202-24-354-TRA1U
RAM® Track Ball™ Kit

Drill-down and Track Ball™ mounts for Piranha MAX Series



RAM-B-107-1U
Marine-Grade Aluminum

RAP-B-107-1U
High-Strength Composite



RAP-B-107-1B-354-TRA1U
RAM® Track Ball™ Kit



RAM® UNIVERSAL ADAPT-A-POST™ TRACK BASES KAYAKING

The RAM® Universal Adapt-A-Post™ is the revolutionary answer to combine compatibility across post and spline systems from RAM® Mounts, Scotty, Fish-On, Railblaza, Cannon, Brocraft, Cabela's, and Bass Pro Shops. Available for all mounting locations including tracks, flat surfaces, rails, and Hobie's H-Rail system, the Universal Adapt-A-Post™ is a true game changer. Each version features a quick-release button to safely disengage the rod holder as well as keep it secure while fishing out on the water.

FEATURES

		
<p>Universal post & spline insert compatible with most brands</p>	<p>Quick-release mechanism for easy insertion and removal of rod holder</p>	<p>Track-base version contains locking button to prevent base from spinning loose</p>



RAP-AAPUTU
RAM® Universal Adapt-A-Post™ Track Base



RAP-AAPUBU
Bulkhead Drill-Down Base



RAP-AAPUDT-1U
Dual T-Bolt Track Base



RAP-AAPUDTU
2-Hole Drill-Down Base



RAP-AAPUDU
4-Hole Drill-Down Base

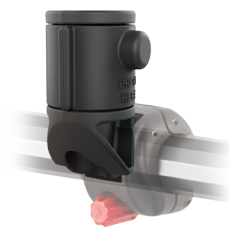

RAP-AAPUH-1U
For Hobie H-Rail Adapters

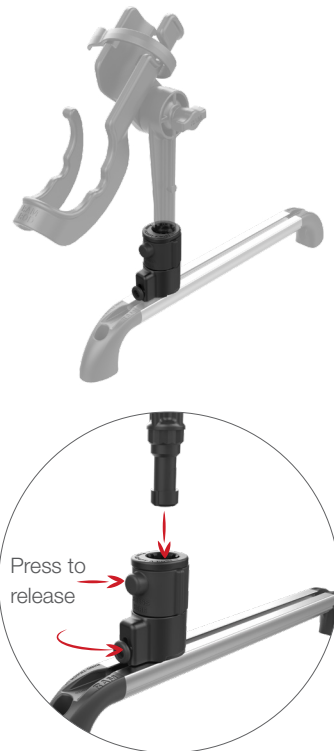

RAM ROD® COMPONENTS

There is no shortage of areas you can mount your rod holders. RAM® offers a variety of different bases and extension arms to achieve the ideal mounting setup for fishing rods for both boating and kayaking. All rod holder components are designed to swap between your type of rod holder, making it easier to shop for what you need, hassle-free.

HOLDERS



RAP-394-SSTU
RAM® Tough-Tube™ with 2" Post



RAP-434-NB
RAM ROD® JR with 2" Post



**BEST
SELLER**

RAP-433-NB
RAM ROD® HD with 6" Post



RAM-114-NBU
RAM ROD® with 6" Post



RAP-390U
RAM® Tube Jr.™ with 6" Post

SPLINE POST BASES



RAM-114BMU
Bulkhead Base



RAM-114FMU
Flush Base



RAM-114BMPU
Combo Bulkhead Base



**BEST
SELLER**

RAP-421
Dual T-Bolt
Track Base



RAP-411-AAPU
RAM® Track-Node™ with
Adapt-A-Post™

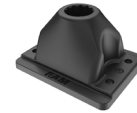

RAM-114DTMU
Deck and Track Base

EXTENSIONS & ACCESSORIES



RAM-114RMU
RAM ROD® Rail Adapter



**BEST
SELLER**

RAP-114-APB2U
Adjustable 13.5" Extension Arm



RAP-114-APB3U
Adjustable 16" Extension Arm



RAP-114-EX6
9" Extension Pole



SEE PAGE 67 FOR **FISHING ROD HOLDERS**

RAM ROD® POPULAR MOUNTS



RAP-114-421
RAM ROD® with
Dual T-Bolt Track Base



RAM-114-BU
RAM ROD® with
Bulkhead Base



RAP-390-RB-TRA1U
RAM® Tube Jr.™ with
Track Ball™ Base



RAP-434-BMP
RAM ROD® JR with
Combo Bulkhead Base

[EXPLORE RAM ROD® KITS](#)

SEEN IN THIS PHOTO:

RAP-385-12-394
RAM® Tough-Tube™ with
RAM® Press-N-Lock™ Base





SEEN IN THIS PHOTO:

RAM-B-316-18-TRA1-TRA1U

RAM® Track Ball™ with 18" Transducer Mount

TRANSDUCER MOUNTS

KAYAKING

Kayak fishing is all about adaptability, and RAM® Mounts offers the widest selection of kayak fishing accessories to adapt to a wide range of fishing scenarios. This transducer arm for kayaks enables the quick and effective deployment and retrieval of your transducer, while protecting your transducer from damage. Perfect for kayak applications, the transducer arm can quickly be retrieved if you enter shallow water or when beaching your kayak.

FEATURES



Flex rod allows for optimal adjustment to prevent drag



Compatible with any transducer with a 1/4" screw



Quick deployment and retrieval hinge

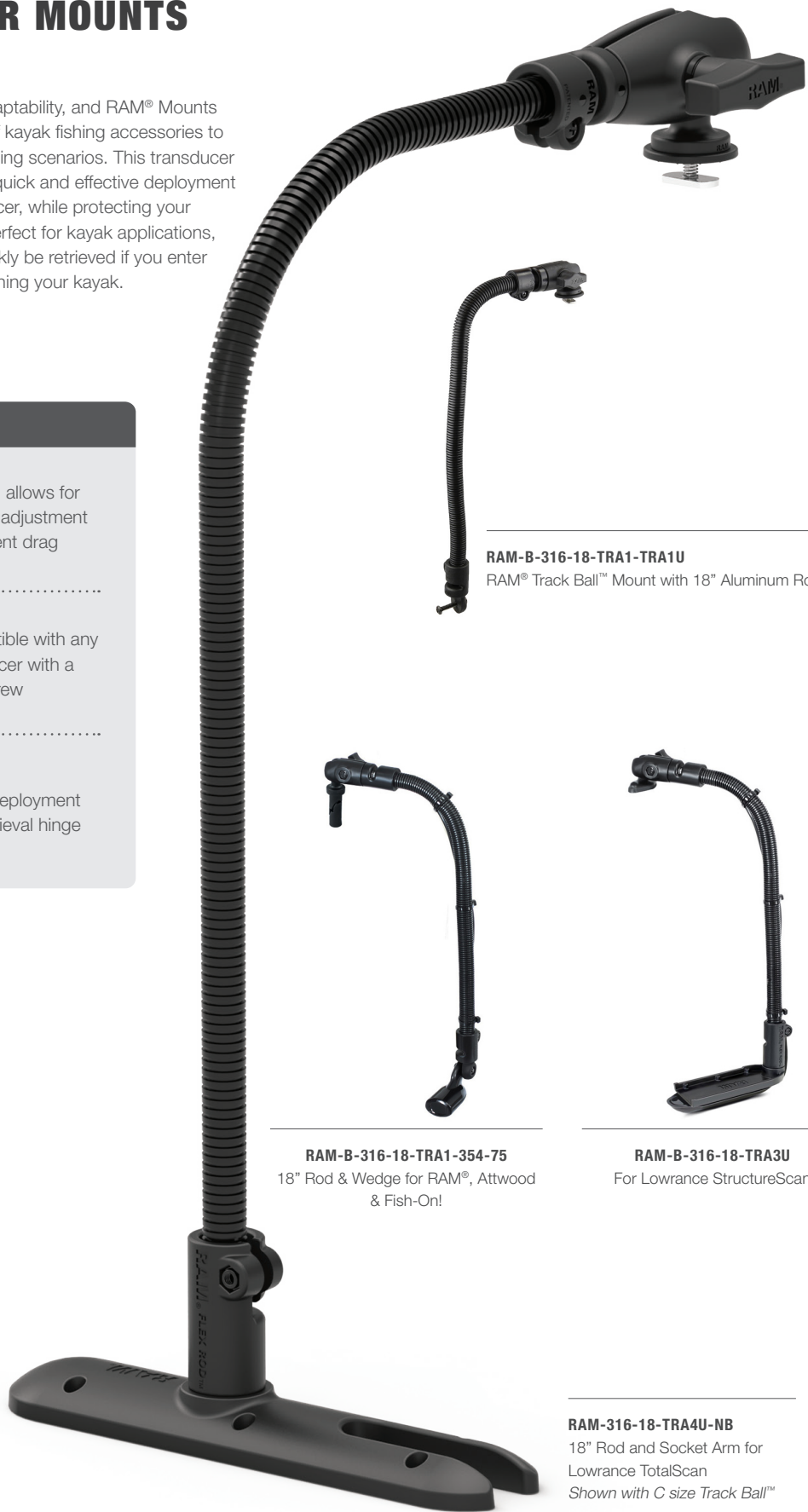

RAM-B-316-18-TRA1-TRA1U
RAM® Track Ball™ Mount with 18" Aluminum Rod



RAM-B-316-18-TRA1-354-75
18" Rod & Wedge for RAM®, Attwood & Fish-On!



RAM-B-316-18-TRA3U
For Lowrance StructureScan

RAM-316-18-TRA4U-NB
18" Rod and Socket Arm for Lowrance TotalScan
Shown with C size Track Ball™



SEEN IN THIS PHOTO:

RAM-B-202-GOP1-201U

RAM® Double Socket Arm with Universal
Action Camera Adapter

RAM-B-408-37-62U

RAM® Torque™ Small Rail Base



DEVICE MOUNTS

FEATURED PRODUCTS

Stay worry-free on the water with RAM® phone, tablet, camera mounts, and more. With popular options like the RAM® X-Grip® and form-fitting cradles, take full advantage of your favorite devices apps and maps— from our favorite action camera brands, including GoPro and DJI, to phones and tablets, you can trust RAM® to keep your devices secure while out on the water.



RAM-B-166-UN7U
RAM® X-Grip® Suction Cup Kit



RAM-HOL-UN10-400-2U
Low-Profile RAM® X-Grip® Kit



RAM-B-400-A-UN12W-V7M-1
RAM® Tough-Charge™ with Tough-Claw™



RAM-B-138-PD4U
RAM® Quick-Grip™ Drill-Down Kit



RAM-HOL-PD4-400-1U
Low-Profile Quick-Grip™ Kit



RAM-B-400-A-UN14W-V7M-1
RAM® Quick-Grip™ Wireless with Tough-Claw™



RAM-B-400-GOP1U
Action Camera Tough-Claw™ Kit



RAP-411-18-18-A-GOP1-1
Action Camera Tough-Pole™ Kit



RAM-HOL-GA76U
RAM® Spine Clip for Garmin Devices



SEEN IN THIS PHOTO:

RAP-HOL-UN7B-354-TRA1U
 RAM® X-Grip® Phone Mount
 with RAM® Track Ball™ Base

DEVICE MOUNTS CONTINUED

PHONE RAM® X-GRIP®

BUILD YOUR KIT WITH THE
RAM® MOUNT BUILDER

The RAM® X-Grip® is the most durable universal phone holder on the market. The spring-loaded arms expand and contract to provide a perfect fit for your phone with or without a case. Available for phones of all sizes, the RAM® X-Grip® secures your device while keeping it completely functional and accessible. No matter what mounting base you pair the RAM® X-Grip® with, the RAM® ball and socket technology allows for near-infinite adjustability and extends the life of your phone with vibration damping capabilities.



RAM-HOL-UN7BU
 RAM® X-Grip™ for Small Phones



RAM-HOL-UN10BU
 RAM® X-Grip™ for Large Phones

FEATURES



Spring-loaded 'X' design with rubber caps provides a secure fit



Leaves buttons and posts exposed and accessible



Includes safety tether for extra peace of mind

POPULAR MOUNTS



RAM-B-177-UN7U
 Glare Shield Clamp Mount



RAP-B-299-4-UN7U
 Stubby™ Cup Holder Mount



RAM-B-400-HOL-UN7BU
 Tough-Claw™ Rail Mount

EXPLORE RAM® X-GRIP® KITS



SEEN IN THIS PHOTO:

RAM-B-166-PD4U

RAM® Quick-Grip™ XL Phone Mount with Twist-Lock™ Suction Cup

DEVICE MOUNTS CONTINUED

PHONE
RAM® QUICK-GRIP™

Capable of holding a broad range of electronics, the spring-loaded grips on the RAM® Quick-Grip™ provide a secure fit for your phone with or without a case. Take advantage of efficient one-handed insertion and removal of your device, no matter if the device is in portrait or landscape. The adjustable optional side support arms add extra security and can shift to fit the width of your device perfectly.



RAM-HOL-PD3-238AU
RAM® Quick-Grip™ for Small Phones

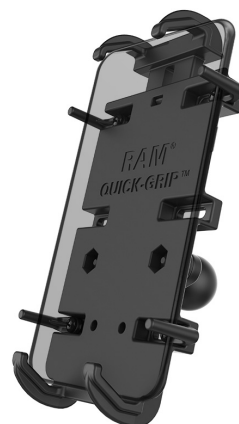

RAM-HOL-PD4-238AU
RAM® Quick-Grip™ XL for Large Phones

FEATURES

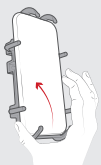

One-handed docking and removal

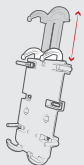

Spring-loaded top grip keeps device in place

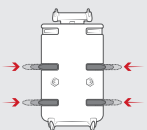

Adjustable side supports for wider devices

POPULAR MOUNTS



RAM-B-138-PD4U
Drill-Down Mount



RAM-B-166-PD3
Twist-Lock™ Suction Cup Mount



RAM-B-149Z-A-PD3
U-Bolt Rail Mount

EXPLORE RAM® QUICK-GRIP™ KITS

DID YOU KNOW

RAM® Wireless Chargers come with a waterproof silicone sleeve that fits over the USB cable, keeping your USB connection safe and secure.

SEEN IN THIS PHOTO:

RAM-B-400-A-UN12W-V7M-1

RAM® Tough-Charge™ Waterproof Wireless Charging Mount with Tough-Claw™



SEEN IN THIS PHOTO:

RAM-B-166-UN14W-1

RAM® Quick-Grip™ Waterproof Wireless Charging Suction Cup Mount

PHONE WIRELESS CHARGING HOLDERS

The RAM® Tough-Charge™ with X-Grip® Technology and RAM® Quick-Grip™ Wireless are the world's first patented, universal, waterproof wireless charging cradles for smartphones. Designed with spring-loaded technology, utilize the best parts of both the RAM® X-Grip® and Quick-Grip™ phone holders while pairing any smartphone with wireless charging capabilities. For added security and peace of mind, a safety tether is included that's recommended for outdoor applications. Available in a variety of mounting kits, ensure wireless charging capabilities across a wide range of vessels.

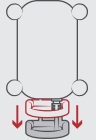
FEATURES	
 <p>RAM® Quick-Grip™ allows for one-handed docking</p>	 <p>RAM® Tough-Charge™ includes adjustable support leg</p>

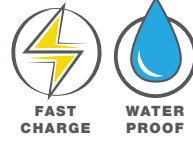

RAM-HOL-UN14WB-1
RAM® Quick-Grip™ Wireless

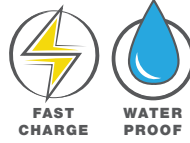

RAM-HOL-UN12WB-1
RAM® Tough-Charge™ Wireless

POPULAR MOUNTS



RAM-B-166-UN14W-1
RAM® Quick-Grip™ Wireless Suction Cup Kit



RAM-B-166-UN12W-1
RAM® Tough-Charge™ Wireless Suction Cup Kit

[EXPLORE WIRELESS CHARGERS](#)

HOW IT WORKS

DOUBLE BALL MOUNTS

BUILD YOUR KIT WITH THE
RAM® MOUNT BUILDER

Choose from a selection of holders, socket arms and ball bases to build a custom mount for your specific needs. Additional bases may be chosen so that your mount can support multiple devices, or can be transferred to alternate mounting locations.

1

CHOOSE A HOLDER

RAM® offers a wide selection of holders for your specific device.

2

CHOOSE AN ARM

Select an arm based on your desired length and placement.

3

CHOOSE A BASE

Select from a variety of bases to help secure your device where you need it.



1 HOLDERS



RAM-HOL-UN10BU
RAM® X-Grip® for Large Phones

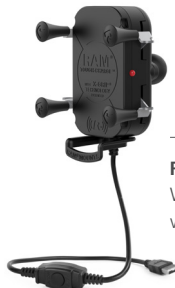

RAM-HOL-UN12WB-1
Wireless RAM® Tough-Charge™ with X-Grip® Technology



RAM-HOL-PD4-238AU
RAM® Quick-Grip™ XL Holder



RAP-B-202U-GOP1
Action Camera Ball Adapter



RAM-HOL-UN8BU
RAM® X-Grip® for 7"-8" Tablets

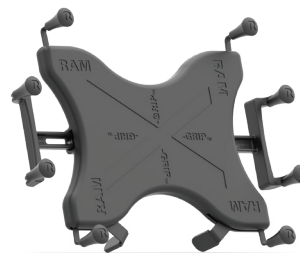

RAM-HOL-UN11U
RAM® X-Grip® for 11"-12" Tablets

2 SOCKET ARMS



RAM-B-201U-A
2.42" Short Socket Arm



RAM-B-201U
3.73" Medium Socket Arm



RAM-B-201U-C
6" Long Socket Arm



RAP-BC-201U
Swivel Arm for Connecting B & C Size Arms



RAP-B-200-12U
Double Socket Swivel Arm



RAP-B-200-2U
Double Socket Swivel & Ratchet Arm

3 BASES



RAM-B-378U
Flex Adhesive Ball Base



RAM-B-202U
Round Drill-Down Base



RAM-B-238U
Diamond Drill-Down Base



RAM-B-224-1U
Twist-Lock™ Suction Cup Base



RAP-B-400U
Tough-Claw™ Clamp Base



RAP-B-354U-TRA1
Track Ball™ with T-Bolts



RAM-109VS-4U
Vertical 6" Swing Arm Mount



RAM-109H-G1U
Horizontal 12" Swing Arm Mount

MORE COMPONENTS AVAILABLE AT
RAMMOUNT.COM/COMPONENTS

SEEN IN THIS PHOTO:

RAM-B-166-UN8U

RAM® X-Grip® with Twist-Lock™
Suction Cup Mount



TABLET MOUNTS

BUILD YOUR KIT WITH THE
RAM® MOUNT BUILDER

Using a tablet with fishing apps and navigation is a viable option made easier by RAM® Mounts utilizing the Tab-Tite™, EZ-Roll'r™, and RAM® X-Grip® holders. Pair with a wide variety of mounting bases and socket arms designed for boating in both fresh water and salt water. Each tablet holder is designed to fit your specific need, combined with the modularity of RAM® Mounts components makes these mounts ideal for any tablet you may own used for fishing or recreation. RAM® Mounts knows you need to trust that your tablet out on the water has proper security, so that's why we've ensured that each tablet holder is more than capable of handling the harshest environments.

FEATURES



RAM® EZ-Roll'r™ provides form-fit to a specific caseless tablet

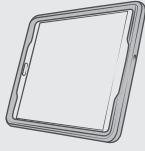

Designed to fit most tablets with and without heavy duty cases



RAM® X-Grip® available for tablets of all sizes



RAM-HOL-AP36U
RAM® EZ-Roll'r™ Cradle for Apple iPad mini 6



RAM-HOL-TAB20U
Tab-Tite™ for 9" Tablets with Heavy Duty Cases



RAM-HOL-UN8BCU
RAM® X-Grip® for 7"-8" Tablets



RAM-HOL-UN9U
RAM® X-Grip® for 9"-10" Tablets

SEEN IN THIS PHOTO:

RAM-400-379-252025U

Tough-Ball™ Camera Mount with
RAM® Tough-Claw™



CAMERA ADAPTERS

BUILD YOUR KIT WITH THE
RAM® MOUNT BUILDER

Capture the best photos and video possible with the help of RAM® Mounts camera ball adapters, allowing for the perfect angle and a secure hold. Constructed with the highest quality materials, the RAM® ball design dampens shock and vibration to help the camera's image stabilization for a smooth video. Discover the GoPro® base adapter, specifically designed for GoPro® action cameras and easily replaces the factory mount. The RAM® universal action camera adapter securely attaches to any compatible action camera, and the RAM® Tough-Ball™ with 1/4"-20 threaded stud is ideal for mounting any cameras including DSLR's and 360 cameras.



RAP-B-202U-GOP1
RAM® Action Camera Ball Adapter



RAP-B-202U-GOP2
RAM® Ball Adapter for GoPro® Bases



RAP-B-379U-252025
1/4"-20 x .25" Tough-Ball™

[EXPLORE ACTION CAMERA KITS](#)

[EXPLORE GOPRO® KITS](#)

[EXPLORE TOUGH-BALL™ KITS](#)

POPULAR MOUNTS



RAP-B-GOP2-A-GOP1
RAM® Ball Adapter for GoPro® Bases Kit



RAP-B-202-GOP1-354-TRA1U
Action Camera Track Ball™ Kit



RAP-B-400-GOP1
Action Camera Tough-Claw™ Kit



RAM-B-238-379U-252025
1/4"-20 Drill-Down Kit



RAP-B-366-153-354-TRA1U
1/4"-20 Track Ball™ Kit



RAM-400-379-252025U
1/4"-20 Tough-Claw™ Kit



SEEN IN THIS PHOTO:

RAP-411-18-A-GOP1

RAM® Tough-Pole™ 24" Camera Mount
with Single Pipe & Dual Track Base

RAM® TOUGH-POLE™ FOR ACTION CAMERAS

Get the ideal angle of your catch with RAM® Tough-Pole™ Action Camera Mounts. Designed to adjust to your desired length, these action camera mounts pair with a variety of mounting bases such as tracks, plungers, flat surfaces, and more to provide a versatile camera setup without getting in the way of your fishing or paddling. Each Tough-Pole™ configuration is equipped with easy-to-assemble components, providing a hassle-free mounting solution. Take advantage of the pole extensions and the wide angle lens of action cameras so you can capture your entire experience.

FEATURES

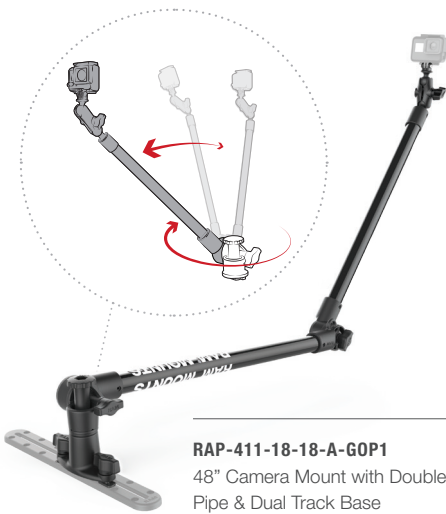
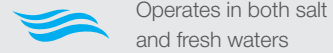
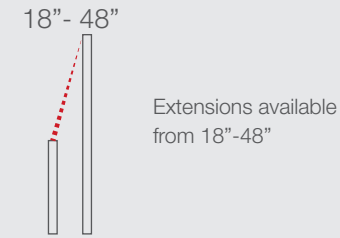
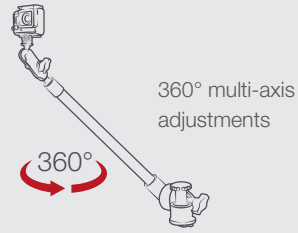

DID YOU **KNOW**

The RAM® Finger-Grip™ was the original universal phone holder, before the RAM® X-Grip® and RAM® Quick-Grip™ existed. However, since this holder can accommodate much thicker devices, the RAM® Finger-Grip™ is still a perfect solution for supporting GPS units and handheld radios.

SEEN IN THIS PHOTO:

RAM-HOL-UN4U

RAM® Finger-Grip™ Universal Phone and Radio Holder

RAP-B-400-238

RAM® Tough-Claw™ Small Clamp Mount with Diamond Plate Base



FEATURES

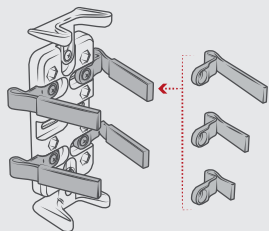

Different finger sizes to accommodate different device thicknesses

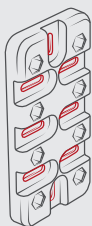

Multiple slotted holes to accommodate buttons and ports

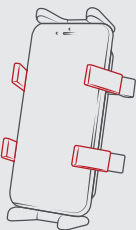

Rubber caps to create friction and firm grip against device

DEVICE MOUNTS CONTINUED

GPS & RADIO MOUNTS

RAM® Mounts offers GPS and radio mounting solutions capable of transferring between your vehicle to your vessel, allowing you to navigate safely and hands-free. From form-fit device mounts such as EZ-Roll'r™ cradles for SPOT, to the Garmin Spine Clip, and universal options utilizing the Finger-Grip™, RAM® has you covered across a wide range of devices. Compatible with top brands including Garmin, SPOT, Midland, BaoFeng and more.



RAM-HOL-UN4U
RAM® Finger-Grip™ Universal Phone and Radio Holder



RAM-HOL-SPO5U
RAM® EZ-Roll'r™ Cradle for SPOT X™



RAM-HOL-GA41
RAM® Form-Fit Cradle for Garmin Astro 320, GPSMAP 62 & 64 Series



RAM-B-202-GA76
RAM® Spine Clip Holder with Ball for Garmin Handheld Devices

ACCESSORIES & MORE

BUILD YOUR KIT WITH THE
RAM® MOUNT BUILDER

FISHFINDER MOUNT ACCESSORIES

Mounting to your boat can be tricky. You don't want to put holes in the wrong areas. Mount your base in the best, most secure locations using our Mari-Nut™ and Mari-Rivet™ mounting hardware paired with the RAM® cable manager; perfect for your fishfinder. The RAM® cable manager acts as a mounting platform for your ball base as well as a neat and organized way of feeding the fishfinder cables through to avoid snags and tangles. Between the large and small sizes, these cable managers are designed to fit bundled cords from any fishfinder, perfectly.



RAP-403U
Cable Manager for B Size &
C Size Fishfinder Mounts



RAM-MARI-RIVET-4U
RAM® Mari-Rivet™ Aluminum Pop Rivets



RAM-MARI-NUT-4
RAM® Mari-Nut™ Rubber Expansion
Mounting Hardware



DID YOU KNOW

If you want to transfer your Fishfinder to multiple mounting locations, you can have multiple drill-down ball bases installed at various locations. You can even transfer from Kayak to Boat.

HI-TORQ™ WRENCH & LOCKING KNOBS

Security is a big focus area for RAM® Mounts—that's why locking accessories are available for all socket arms and swing arm mounts. Designed with patented locking patterns, these locking knobs are swappable with the arm's knob to convert your mount for theft deterrence. Use the Hi-Torq™ Wrench to ensure your heavy duty fishfinder is tightened into place. This handy tool makes handling and adjusting the position of all the extra weight much easier.



RAM-KNOB9HU

Hi-Torq™ Wrench for D Size Socket Arms



RAP-S-KNOB5U

Pin-Lock™ Security Knob for C Size Socket Arms



RAP-S-KNOBG-109U

Pin-Lock™ Security Kit for Single Swing Arms and Gimbal Brackets

RAP-S-NUT5U

Pin-Lock™ Security Nut for D Socket Arms

RAP-S-KNOBG-109-1U

Pin-Lock™ Security Kit for Double Swing Arms and Gimbal Brackets



PADDLEBOARD & INFLATABLE CRAFT MOUNTS

Paddleboards need mounts too! RAM® utilizes phone holders and action camera mounts with RAM® components to create ideal paddleboard mounts—designed to fit securely on a wet, flat surface. Between flat surface mounting options that do not require drilling into the board, to leash plug adapters, these mounts are all you need to mount your desired device.



RAP-399U
Float Tube Strap Ball Base



RAP-B-405U
Leash Plug Ball Adapter



RAP-406U
Leash Cup



RAP-398-BLK-TRACK-AU
Bond-A-Base™ Adhesive Base
with Tough-Track™



RAP-398-BLK-114BMPU
Bond-A-Base™ Adhesive Base
with RAM ROD® Post/Spline Receiver



RAP-398-BLK-202U
Bond-A-Base™ Adhesive Base
with C Size Ball



DRINK HOLDERS

EXPLORE DRINK HOLDERS



RAM-B-132-400U

Level Cup™ with Tough-Claw™ for 16oz Drinks



RAM-B-417B-C-354-TRA1U

Level Cup™ XL with Track Ball™ for 32oz Drinks



RAP-224-429

Drink Holder with Suction Cup Base

PADDLE HOLDERS

EXPLORE PADDLE HOLDERS



RAP-430-224U

Tough-Clip™ Paddle Holder with Suction Cup Base

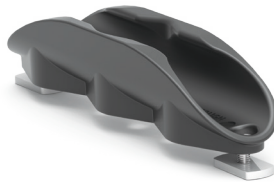

RAP-430TDU

Tough-Clip™ Paddle Holder with Track Bolts



RAP-412U

Roller-Ball™ Paddle & Accessory Holder



RAM® TOUGH-TRACK™

From a wide variety of lengths and track styles to choose from, RAM® Tough-Tracks™ are fully customizable solutions with thousands of configurations. Able to support multiple devices, these tracks are designed to handle specific weights, a wide variety of devices, and mounting locations. Take advantage of the modular aluminum tracks that include connector pieces that extend the length of the track system and create corners for multi-directional mounting. Not interested in drilling into your vessel? RAM® offers hand tracks and rail mounted tracks for easy install and removal of the entire system.



MODULAR ALUMINUM

[EXPLORE MODULAR ALUMINUM](#)

Available in track lengths from 3" to 17"



■ **RAM-TRACK-EXA-9U**
9" RAM® Tough-Track™



■ **RAM-TRACK-EXA-9BU**
9" Black RAM® Tough-Track™

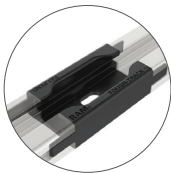

RAP-TRACK-EXA-CCU
Center Connector for
RAM® Tough-Track™

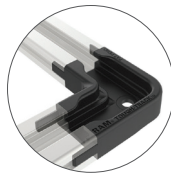

RAP-TRACK-EXA-CC90U
90-Degree Connector for
RAM® Tough-Track™



POPULAR COMPONENTS & KITS

[EXPLORE TRACK KITS](#)



RAP-B-354U-TRA1
RAM® Track Ball™ - B Size



RAP-354U-TRA1
RAM® Track Ball™ - C Size



RAP-HOL-UN7B-354-TRA1U
RAM® X-Grip® Track Kit



RAP-B-202-GOP1-354-TRA1U
Action Camera Track Kit

TOP-LOADING COMPOSITE

[EXPLORE TOP-LOADING COMPOSITE](#)

Available in track lengths from 2.43" to 16"



RAP-TRACK-A9
9" Top-Loading Composite Tough-Track™



RAP-401-TRACKU
10.75" Tough-Track™ with RAM® Tough-Claw™



RAM® HAND-TRACK™

[EXPLORE RAM® HAND-TRACK™](#)

Available in track lengths from 4" to 30"



RAM-TRACK-H6U
6" Hand-Track™ with 12" Overall Length



RAM-TRACK-HC-6U
Hand-Track™ Center Connector with 6" Extension



RAP-B-366-153-354-TRA1U
1/4"-20 Adapter Track Kit



RAP-B-202-GA76-TRA1U
Garmin Spine Clip Track Kit

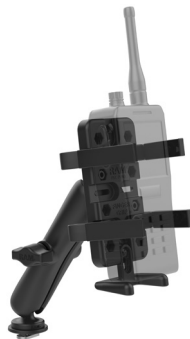

RAM-HOL-UN4-C-354-TRA1U
Finger-Grip™ Track Kit



RAM-HOL-PD4-C-354-TRA1U
Quick-Grip™ Track Kit



SEEN IN THIS PHOTO:

RAP-400-202U

RAM® Tough-Claw™

Trolling Motor Stabilizer

TROLLING MOTOR STABILIZERS

The RAM® Tough-Claw™ is the perfect mounting base for quick and easy tool-less installation and removal on round, square, odd shaped rails, and bars. The Tough-Claw™ can be converted into the most versatile mounting option for motor stabilizers. Simply tighten the grip of the Tough-Claw™ attached to the motor stabilizer and attach the drill-down base to the most effective location on the vessel to achieve the perfect mount.

FEATURES

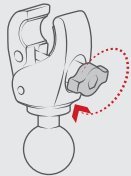

RAM® Tough-Claw™ ensures strongest hold

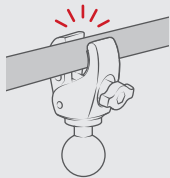

Easily adjust positions by simply loosening grip

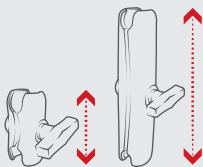

Multi-length socket arms for desired height



RAP-400-202U
Tough-Claw™ Trolling Motor Stabilizer



RAP-400U
RAM® Tough-Claw™ Small Clamp Ball Base



RAM-108BU
RAM® Strap Hose Clamp Base



RAM-108
Strap Hose Clamp Trolling Motor Stabilizer



SEEN IN THIS PHOTO:

RAP-398-BLK-TRACK-A

RAM® Bond-A-Base™ with RAM® Tough-Track™

RAP-B-202-GOP1-354-TRA1

RAM® Track Ball™ with Action Camera Adapter

RAP-432

RAM® Tough-Cleat™

SECURITY MOUNTS

TOUGH-CLEAT / TIE-DOWNS / ANCHOR LINE

Tie-downs are critical on kayaks, and RAM® Mounts supplies strong track-based components that are easy to use and compatible with RAM® Tough-Tracks™ and most third party track systems. Keeping the versatility of the RAM® mounting system, these mounts are designed to be easy to remove and install while providing a strong hold worthy of securing your supplies. Paired with a lifetime warranty, these tie-down mounts are a must-have add-on for any kayak.



RAP-432U

RAM® Tough-Cleat™ Anchor Tie-Off with Track Adapter

FEATURES

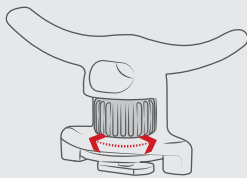

Twist knob to tighten and loosen from track

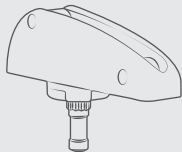

Anchor line mount compatible with post & spline systems



All tie-downs equipped with t-bolts for track mounting



RAP-357PU

RAM® Anchor Line Lock with Post



RAP-431U

RAM® 2-Pack Vertical Tie Down Track Accessory

DID YOU KNOW

The LED Bulb in this spotlight is replaceable. RAM® offers replacement LED bulbs, or you can replace with any 3rd party PAR36 bulb.



SEEN IN THIS PHOTO:

RAM-B-152-404

RAM® Tough-Claw™ Mount with LED Spotlight

SPOTLIGHT MOUNTS

Fishing at night? RAM® makes all-in-one mounting solutions for LED spotlights and a variety of mounting bases to install anywhere on the vessel. The waterproof casing around the light source is all one piece and can easily be removed to replace the bulb. A pre-installed RAM® ball ensures these spotlights are compatible with all B size components in order to create your own custom mount for your desired location and positioning.

FEATURES



**WATER
PROOF**

All-in-one waterproof
rubber housing

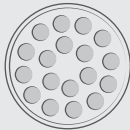

Compatible with any third party
PAR36 LED bulb



Built-in 10' extension cord



RAM-B-152-404

RAM® Tough-Claw™ Double Ball Mount with LED Spotlight



RAM-B-152-231Z-2

Strap Hose Clamp Mount with
LED Spotlight

PRODUCT CHARTS & COMPATIBILITY



KAYAKING FISHFINDER COMPATIBILITY

MAKE	MODEL	BALL ADAPTER	DOUBLE BALL MOUNT
Garmin	GPSMAP 7607 / xsv	RAM-111BU	"111" Series
	GPSMAP 7407 / xsv	RAM-111BU	"111" Series
	GPSMAP 7608 / xsv	RAM-111BU	"111" Series
	GPSMAP 7408 / xsv	RAM-111BU	"111" Series
	GPSMAP 742 / xs Plus	RAM-111BU	"111" Series
	GPSMAP 722 / xs Plus	RAM-111BU	"111" Series
	GPSMAP 942 / xs Plus	RAM-111BU	"111" Series
	GPSMAP 922 / xs Plus	RAM-111BU	"111" Series
	Echomap Plus 42cv	RAM-B-202-G4U	RAM-B-101-G4 (See Custom mounts)
	Echomap Plus 43cv	RAM-B-202-G4U	RAM-B-101-G4 (See Custom mounts)
	Echomap Plus 44cv	RAM-B-202-G4U	RAM-B-101-G4 (See Custom mounts)
	Echomap Plus 45cv	RAM-B-202-G4U	RAM-B-101-G4 (See Custom mounts)
	Echomap UHD 62cv	RAM-111BU	"111" Series
	Echomap UHD 63cv	RAM-111BU	"111" Series
	Echomap UHD 64cv	RAM-111BU	"111" Series
	Echomap UHD 65cv	RAM-111BU	"111" Series
	Echomap UHD 72sv	RAM-111BU	"111" Series
	Echomap UHD 73sv	RAM-111BU	"111" Series
	Echomap UHD 74sv	RAM-111BU	"111" Series
	Echomap UHD 75sv	RAM-111BU	"111" Series
	Echomap UHD 92sv	RAM-111BU	"111" Series
	Echomap UHD 93sv	RAM-111BU	"111" Series
	Echomap UHD 94sv	RAM-111BU	"111" Series
	Echomap UHD 95sv	RAM-111BU	"111" Series
	Echomap Plus 62cv	RAM-111BU	"111" Series
	Echomap Plus 63cv	RAM-111BU	"111" Series
	Echomap Plus 64cv	RAM-111BU	"111" Series
	Echomap Plus 65cv	RAM-111BU	"111" Series
	Echomap Plus 72sv	RAM-111BU	"111" Series
	Echomap Plus 73sv	RAM-111BU	"111" Series
	Echomap Plus 74sv	RAM-111BU	"111" Series
	Echomap Plus 75sv	RAM-111BU	"111" Series
	Echomap Plus 77sv	RAM-111BU	"111" Series
	Echomap Plus 92sv	RAM-111BU	"111" Series
	Echomap Plus 93sv	RAM-111BU	"111" Series
	Echomap Plus 94sv	RAM-111BU	"111" Series
	Echomap Plus 95sv	RAM-111BU	"111" Series
	Echomap Plus 97sv	RAM-111BU	"111" Series
	echoMAP CHIRP 43cv	RAM-B-202-G4U	RAM-B-101-G4 (See Custom mounts)
	echoMAP CHIRP 73cv	RAM-111BU	"111" Series
	echoMAP CHIRP 74cv	RAM-111BU	"111" Series
	echoMAP CHIRP 75cv	RAM-111BU	"111" Series
	echoMAP CHIRP 74sv	RAM-111BU	"111" Series
	echoMAP CHIRP 94sv	RAM-111BU	"111" Series
	echoMAP CHIRP 93sv	RAM-111BU	"111" Series
STRIKER Plus 4	RAM-B-202-G4U	RAM-B-101-G4 (See Custom mounts)	
STRIKER Plus 4cv	RAM-B-202-G4U	RAM-B-101-G4 (See Custom mounts)	
STRIKER Plus 5cv	RAM-B-111BU	"B-111" Series	
STRIKER Plus 7cv	RAM-111BU	"111" Series	
STRIKER Plus 7sv	RAM-111BU	"111" Series	
STRIKER Plus 9sv	RAM-111BU	"111" Series	
STRIKER 4	RAM-B-202-G4U	RAM-B-101-G4 (See Custom mounts)	

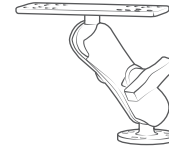
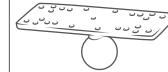
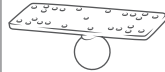

MAKE	MODEL	BALL ADAPTER	DOUBLE BALL MOUNT
Humminbird	Helix 5	RAM-202U-153	RAM-202-153-202U (See Custom mounts)
	Helix 7	RAM-202U-24	RAM-202-24-202U (See Custom Mounts)
	Helix 8	RAM-111BU	"111" Series
	Helix 9	RAM-111BU	"111" Series
PiranhaMax 4		RAM-B-107-1BU	RAM-B-107-1U (See Custom Mounts)
	HOOK Reveal 5	RAM-B-202-LO12	RAM-B-101-LO12 (See Custom Mounts)
Lowrance	HOOK Reveal 7	RAM-111BU	"111" Series
	HOOK Reveal 9	RAM-111BU	"111" Series
	Elite-7 Ti2	RAM-202U-LO11	RAM-101-LO11 (See Custom Mounts)
Raymarine	Elite-9 Ti2	RAM-111BU	"111" Series
	HDS-7 LIVE	RAM-111BU	"111" Series
	HDS-9 LIVE	RAM-111BU	"111" Series
Dragonfly 5 Pro		RAP-B-379U-M616	RAM-B-202-379-M616
	Dragonfly 7 Pro	RAP-B-379U-M616	RAM-B-202-379-M616

BOATING FISHFINDER COMPATIBILITY

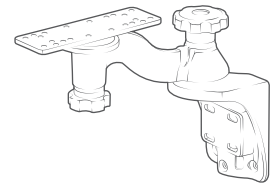
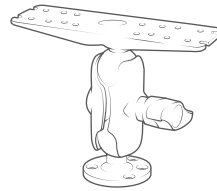
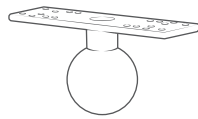

MAKE	MODEL	BALL ADAPTER	DOUBLE BALL MOUNT	SWING ARM MOUNT
Garmin	GPSMAP 8616 / xsv	RAM-D-115BU	"D-115" Series	"109" Series
	GPSMAP 8416 / xsv	RAM-D-115BU	"D-115" Series	"109" Series
	GPSMAP 8610 / xsv	RAM-D-115BU	"D-115" Series	"109" Series
	GPSMAP 8410 / xsv	RAM-D-115BU	"D-115" Series	"109" Series
	GPSMAP 8612 / xsv	RAM-D-115BU	"D-115" Series	"109" Series
	GPSMAP 8412 / xsv	RAM-D-115BU	"D-115" Series	"109" Series
	GPSMAP 7607 / xsv	RAM-111BU	"111" Series	"109" Series
	GPSMAP 7407 / xsv	RAM-111BU	"111" Series	"109" Series
	GPSMAP 7608 / xsv	RAM-111BU	"111" Series	"109" Series
	GPSMAP 7408 / xsv	RAM-111BU	"111" Series	"109" Series
	GPSMAP 7610 / xsv	RAM-D-111BU	"D-111" Series	
	GPSMAP 7410 / xsv	RAM-D-111BU	"D-111" Series	
	GPSMAP 7612 / xsv	RAM-D-111BU	"D-111" Series	
	GPSMAP 7412 / xsv	RAM-D-111BU	"D-111" Series	
	GPSMAP 7616 / xsv	RAM-D-111BU	"D-111" Series	
	GPSMAP 7416 / xsv	RAM-D-111BU	"D-111" Series	
	GPSMAP 742 / xs Plus	RAM-111BU	"111" Series	"109" Series
	GPSMAP 722 / xs Plus	RAM-111BU	"111" Series	"109" Series
	GPSMAP 942 / xs Plus	RAM-D-115BU	"D-115" Series	"109" Series
	GPSMAP 922 / xs Plus	RAM-D-115BU	"D-115" Series	"109" Series
	GPSMAP 1222 / xsv Plus	RAM-D-111BU	"D-111" Series	
	GPSMAP 1242 / xsv Plus	RAM-D-111BU	"D-111" Series	
	GPSMAP 1022	RAM-D-111BU	"D-111" Series	
	GPSMAP 1022xsv	RAM-D-111BU	"D-111" Series	
	GPSMAP 1042xsv	RAM-D-111BU	"D-111" Series	
	GPSMAP 1222	RAM-D-111BU	"D-111" Series	
	GPSMAP 1222xsv	RAM-D-111BU	"D-111" Series	
	GPSMAP 1242xsv	RAM-D-111BU	"D-111" Series	
	Echomap Ultra 10"	RAM-D-111BU	"D-111" Series	
	Echomap Ultra 12"	RAM-D-111BU	"D-111" Series	
	Echomap Ultra 2 10"	RAM-D-115BU	"D-115" Series	"109" Series
	Echomap Ultra 2 12"	RAM-D-115BU	"D-115" Series	"109" Series
	Echomap Plus 42cv	RAM-202-G4U	RAM-101-G4 (See Custom mounts)	
	Echomap Plus 43cv	RAM-202-G4U	RAM-101-G4 (See Custom mounts)	
	Echomap Plus 44cv	RAM-202-G4U	RAM-101-G4 (See Custom mounts)	
	Echomap Plus 45cv	RAM-202-G4U	RAM-101-G4 (See Custom mounts)	
	Echomap UHD 62cv	RAM-111BU	"111" Series	"109" Series
	Echomap UHD 63cv	RAM-111BU	"111" Series	"109" Series
	Echomap UHD 64cv	RAM-111BU	"111" Series	"109" Series
	Echomap UHD 65cv	RAM-111BU	"111" Series	"109" Series
	Echomap UHD 72sv	RAM-111BU	"111" Series	"109" Series
	Echomap UHD 73sv	RAM-111BU	"111" Series	"109" Series
	Echomap UHD 74sv	RAM-111BU	"111" Series	"109" Series
	Echomap UHD 75sv	RAM-111BU	"111" Series	"109" Series
	Echomap UHD 92sv	RAM-D-115BU	"D-115" Series	"109" Series
	Echomap UHD 93sv	RAM-D-115BU	"D-115" Series	"109" Series
	Echomap UHD 94sv	RAM-D-115BU	"D-115" Series	"109" Series
	Echomap UHD 95sv	RAM-D-115BU	"D-115" Series	"109" Series
	Echomap Plus 62cv	RAM-111BU	"111" Series	"109" Series
	Echomap Plus 63cv	RAM-111BU	"111" Series	"109" Series
Echomap Plus 64cv	RAM-111BU	"111" Series	"109" Series	
Echomap Plus 65cv	RAM-111BU	"111" Series	"109" Series	
Echomap Plus 72sv	RAM-111BU	"111" Series	"109" Series	
Echomap Plus 73sv	RAM-111BU	"111" Series	"109" Series	
Echomap Plus 74sv	RAM-111BU	"111" Series	"109" Series	
Echomap Plus 75sv	RAM-111BU	"111" Series	"109" Series	

BOATING FISHFINDER COMPATIBILITY

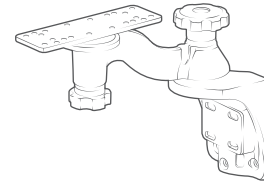
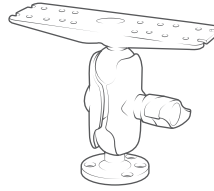
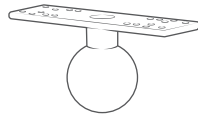

MAKE	MODEL	BALL ADAPTER	DOUBLE BALL MOUNT	SWING ARM MOUNT
Garmin	Echomap Plus 77sv	RAM-111BU	"111" Series	"109" Series
	Echomap Plus 92sv	RAM-D-115BU	"D-115" Series	"109" Series
	Echomap Plus 93sv	RAM-D-115BU	"D-115" Series	"109" Series
	Echomap Plus 94sv	RAM-D-115BU	"D-115" Series	"109" Series
	Echomap Plus 95sv	RAM-D-115BU	"D-115" Series	"109" Series
	Echomap Plus 97sv	RAM-D-115BU	"D-115" Series	"109" Series
	echoMAP CHIRP 43cv	RAM-202-G4U	RAM-101-G4 (See Custom mounts)	
	echoMAP CHIRP 73cv	RAM-111BU	"111" Series	"109" Series
	echoMAP CHIRP 74cv	RAM-111BU	"111" Series	"109" Series
	echoMAP CHIRP 75cv	RAM-111BU	"111" Series	"109" Series
	echoMAP CHIRP 74sv	RAM-111BU	"111" Series	"109" Series
	echoMAP CHIRP 94sv	RAM-D-115BU	"D-115" Series	"109" Series
	echoMAP CHIRP 93sv	RAM-D-115BU	"D-115" Series	"109" Series
	STRIKER Plus 4	RAM-202-G4U	RAM-101-G4 (See Custom mounts)	
	STRIKER Plus 4cv	RAM-202-G4U	RAM-101-G4 (See Custom mounts)	
	STRIKER Plus 5cv	RAM-111BU	"111" Series	"109" Series
	STRIKER Plus 7cv	RAM-111BU	"111" Series	"109" Series
	STRIKER Plus 7sv	RAM-111BU	"111" Series	"109" Series
STRIKER Plus 9sv	RAM-D-115BU	"D-115" Series	"109" Series	
STRIKER 4	RAM-202-G4U	RAM-101-G4 (See Custom mounts)		
Humminbird	Helix 5	RAM-202U-153	RAM-202-153-202U (See Custom mounts)	
	Helix 7	RAM-202U-24	RAM-202-24-202U (See Custom Mounts)	
	Helix 8	RAM-D-202U-25	RAM-D-202-25-C-202U (See Custom Mounts)	"109" Series
	Helix 9	RAM-D-202U-25	RAM-D-202-25-C-202U (See Custom Mounts)	"109" Series
	Helix 10	RAM-D-202U-25	RAM-D-202-25-C-202U (See Custom Mounts)	"109" Series
	PiranhaMax 4	RAM-B-107-1BU	RAM-B-107-1U (See Custom Mounts)	
	Solix 10	RAM-D-202U-25	RAM-D-202-25-C-202U (See Custom Mounts)	"109" Series
	Solix 12	RAM-D-202U-25	RAM-D-202-25-C-202-KNOB9HU (See Custom Mounts)	"109" Series
Solix 15	RAM-D-202U-25	RAM-D-202-25-C-202-KNOB9HU (See Custom Mounts)	"109" Series	
Lowrance	HOOK Reveal 5	RAM-202-LO12	RAM-101-LO12 (See Custom Mounts)	
	HOOK Reveal 7	RAM-111BU	"111" Series	"109" Series
	HOOK Reveal 9	RAM-D-115BU	"D-115" Series	"109" Series
	Elite-7 Ti2	RAM-202U-LO11	RAM-101-LO11 (See Custom Mounts)	RAM-109H-2B-B-LO11
	Elite-9 Ti2	RAM-D-111BU	"D-111" Series	
	Elite-12 Ti2	RAM-D-111BU	"D-111" Series	
	HDS-7 LIVE	RAM-111BU	"111" Series	"109" Series
	HDS-9 LIVE	RAM-D-115BU	"D-115" Series	"109" Series
HDS-12 LIVE	RAM-D-115BU	"D-115" Series	"109" Series	
HDS-16 LIVE	RAM-D-115BU	RAM-D-115-C-KNOB9H	"109" Series	
Raymarine	Dragonfly 5 Pro	RAP-B-379U-M616	RAM-B-202-379-M616	
	Dragonfly 7 Pro	RAP-B-379U-M616	RAM-B-202-379-M616	
	Axiom 7	RAM-D-111BU	"D-111" Series	
	Axiom 9	RAM-D-111BU	"D-111" Series	
	Axiom 12	RAM-D-111BU	"D-111" Series	

FISHFINDER MOUNTS

BALL SIZE SELECTION GUIDE

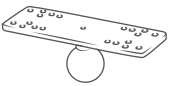
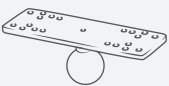
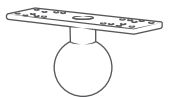
FISHFINDER SCREEN SIZE	VEHICLE TYPE	RECOMMENDED BALL SIZE
 4" - 5" Fishfinders	Kayak	B Size 1"
 4" - 7" Fishfinders	Boat	C Size 1.5"
 Up to 9" Fishfinders	Kayak	C Size 1.5"
 8" - 16" Fishfinders	Boat	D Size 2.25"

"B-111" SERIES

B SIZE 1" BALL WITH 6.25" X 2" PLATE

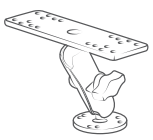
	PART NUMBER	MOUNT FUNCTION	ARM LENGTH	MATERIAL	NOTES
	RAM-B-111B	-	-	-	Marine-Grade Aluminum
RAM-B-111U-A	Drill-Down	Short	Marine-Grade Aluminum	-	
BEST SELLER RAM-B-111	Drill-Down	Medium	Marine-Grade Aluminum	-	
RAM-B-111U-C	Drill-Down	Long	Marine-Grade Aluminum	-	
RAM-B-111-238U	Drill-Down	Medium	Marine-Grade Aluminum	2-Hole Diamond Ball Base	
RAM-S-B-111	Drill-Down	Medium	Marine-Grade Aluminum	RAM® Pin-Lock™ Security Knob Included	
RAM-SG-B-111	Drill-Down	Medium	Marine-Grade Aluminum	RAM® Pin-Lock™ Security Knob & Gimbal Knob Included	
RAP-B-111-A	Drill-Down	Short	High Strength Composite	-	
RAP-B-111	Drill-Down	Medium	High Strength Composite	-	
RAP-B-111B-354-TRA1	Track	Medium	High Strength Composite	-	

"111" SERIES

C SIZE 1.5" BALL WITH 6.25" X 2" PLATE

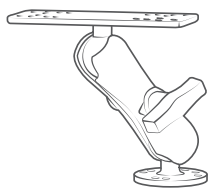
	PART NUMBER	MOUNT FUNCTION	ARM LENGTH	MATERIAL	NOTES
	RAM-111B	-	-	-	Marine-Grade Aluminum
RAM-111-B	Drill-Down	Short	Marine-Grade Aluminum	-	
BEST SELLER RAM-111	Drill-Down	Medium	Marine-Grade Aluminum	-	
RAM-111-D	Drill-Down	Long	Marine-Grade Aluminum	-	
RAM-S-111	Drill-Down	Medium	Marine-Grade Aluminum	RAM® Pin-Lock™ Security Knob Included	
RAM-SG-111	Drill-Down	Medium	Marine-Grade Aluminum	RAM® Pin-Lock™ Security Knob & Gimbal Knob Included	
RAM-111-403U	Drill-Down	Medium	Marine-Grade Aluminum	Cable Manager Included	
RAM-111B-354-TRA1	Track	Medium	Marine-Grade Aluminum	-	
RAP-111	Drill-Down	Medium	High Strength Composite	-	
RAP-111-B	Drill-Down	Short	High Strength Composite	-	

"D-115" SERIES

D SIZE 2.25" BALL WITH 6.25" X 2" PLATE

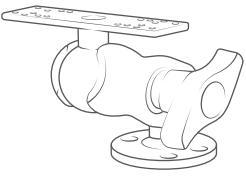
	PART NUMBER	MOUNT FUNCTION	ARM LENGTH	NOTES
	RAM-D-115BU	-	-	-
BEST SELLER RAM-D-115-C	Drill-Down	Short	-	-
RAM-D-115	Drill-Down	Medium	-	-
RAM-D-115-E	Drill-Down	Long	-	-
RAM-D-115-C-KNOB9H*	Drill-Down	Medium	-	RAM® Hi-Torq™ Wrench Included

*RAM® Hi-Torq™ Wrench Required for 16" Fishfinders

FISHFINDER MOUNTS

"D-111" SERIES D SIZE 2.25" BALL WITH 3" X 11" PLATE

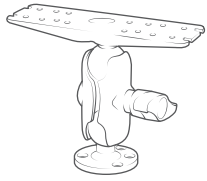

PART NUMBER	MOUNT FUNCTION	ARM LENGTH	NOTES
RAM-D-111BU	-	-	Ball Adapter
BEST SELLER RAM-D-111-C	Drill-Down	Short	-
RAM-D-111	Drill-Down	Medium	-
RAM-D-111U-E	Drill-Down	Long	-
RAM-D-111-C-KNOB9H*	Drill-Down	Short	RAM® Hi-Torq™ Wrench Included
RAM-D-111-KNOB9H*	Drill-Down	Medium	RAM® Hi-Torq™ Wrench Included
RAM-S-D-111	Drill-Down	Medium	RAM® Pin-Lock™ Security Nut Included
RAM-S-D-111U-C	Drill-Down	Short	RAM® Pin-Lock™ Security Nut Included

*RAM® Hi-Torq™ Wrench Required for 16" Fishfinders

"109" SERIES SWING ARM MOUNTS WITH 6.25" X 2" PLATE

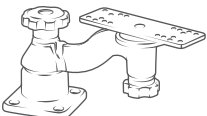

PART NUMBER	BASE TYPE	SWING ARM TYPE	NOTES
BEST SELLER RAM-109H	Horizontal	Single	-
RAM-109H-1	Horizontal	Double	-
RAM-109HSB*	Horizontal	Single	C Size 1.5" Ball & Socket Adapter
RAM-109H-2*	Horizontal	Single w/ Double Socket Arm	C Size 1.5" Ball & Socket Adapter
RAM-109V	Vertical	Single	-
RAM-109V-1	Vertical	Double	-
RAM-109VSB*	Vertical	Medium	C Size 1.5" Ball & Socket Adapter
RAM-109V-2*	Vertical	Single w/ Double Socket Arm	C Size 1.5" Ball & Socket Adapter

*Mounts with C Size 1.5" Ball are only recommended for up to 7" Fishfinders

CUSTOM MOUNTS

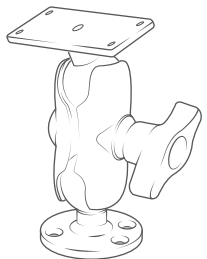

PART NUMBER	BRAND	MODEL	BALL SIZE	MOUNT TYPE	ARM LENGTH	MATERIAL
RAM-B-101-G4	Garmin	Echomap Plus 42-45cv, echo-MAP CHIRP 43cv, STRIKER 4/ Plus 4/cv	B Size 1"	Drill-Down	Medium	Marine-Grade Aluminum
BEST SELLER RAM-101-G4	Garmin	Echomap Plus 42-45cv, echo-MAP CHIRP 43cv, STRIKER 4/ Plus 4/cv	C Size 1.5"	Drill-Down	Medium	Marine-Grade Aluminum
RAP-B-101U-G4	Garmin	Echomap Plus 42-45cv, echo-MAP CHIRP 43cv, STRIKER 4/ Plus 4/cv	B Size 1"	Drill-Down	Medium	High Strength Composite
RAP-101U-G4	Garmin	Echomap Plus 42-45cv, echo-MAP CHIRP 43cv, STRIKER 4/ Plus 4/cv	C Size 1.5"	Drill-Down	Medium	High Strength Composite
RAM-B-107-1	Humminbird	PiranhaMax 4	B Size 1"	Drill-Down	Medium	Marine-Grade Aluminum
RAP-B-107-1B-354-TRA1	Humminbird	PiranhaMax 4	B Size 1"	Track	Medium	High Strength Composite
RAP-B-107-1U	Humminbird	PiranhaMax 4	B Size 1"	Drill-Down	Medium	High Strength Composite
RAM-B-107-1U-238	Humminbird	PiranhaMax 4	B Size 1"	Drill-Down	Medium	Marine-Grade Aluminum
RAM-202-153-B-202	Humminbird	Helix 5	C Size 1.5"	Drill-Down	Short	Marine-Grade Aluminum
RAM-202-153-202U	Humminbird	Helix 5	C Size 1.5"	Drill-Down	Medium	Marine-Grade Aluminum
RAP-B-202-153-354-TRA1	Humminbird	Helix 5	B Size 1"	Track	Medium	High Strength Composite
RAP-202-153-202	Humminbird	Helix 5	C Size 1.5"	Drill-Down	Medium	High Strength Composite
RAM-202-24-B-202U	Humminbird	Helix 7	C Size 1.5"	Drill-Down	Short	Marine-Grade Aluminum
RAM-202-24-202U	Humminbird	Helix 7	C Size 1.5"	Drill-Down	Medium	Marine-Grade Aluminum
RAM-202-24-354-TRA1U	Humminbird	Helix 7	C Size 1.5"	Track	Medium	Marine-Grade Aluminum
BEST SELLER RAM-D-202-25-C-202U	Humminbird	Helix 8, 9, 10, Solix 10, 12, 15	D Size 2.25"	Drill-Down	Short	Marine-Grade Aluminum
RAM-101-LO12	Lowrance	HOOK Reveal 5	C Size 1.5"	Drill-Down	Medium	Marine-Grade Aluminum
RAM-B-101-LO12	Lowrance	HOOK Reveal 5	B Size 1"	Drill-Down	Medium	Marine-Grade Aluminum
BEST SELLER RAM-B-LO12-354-TRA1	Lowrance	HOOK Reveal 5	B Size 1"	Track	Medium	Marine-Grade Aluminum
RAP-101-LO12	Lowrance	HOOK Reveal 5	C Size 1.5"	Drill-Down	Medium	High Strength Composite
RAP-B-101-LO12	Lowrance	HOOK Reveal 5	B Size 1"	Drill-Down	Medium	High Strength Composite
RAM-109H-2B-B-LO11	Lowrance	Elite-7 Ti ²	C Size 1.5"	Drill-Down, Horizontal Swing Arm	Medium + Single Swing Arm	Marine-Grade Aluminum
RAP-101U-LO11	Lowrance	Elite-7 Ti ²	C Size 1.5"	Drill-Down	Medium	High Strength Composite
RAM-B-202-379-M616	Raymarine	Dragonfly 5 Pro, 7 Pro	B Size 1"	Drill-Down	Medium	Marine-Grade Aluminum
RAM-B-400-379-M616	Raymarine	Dragonfly 5 Pro, 7 Pro	B Size 1"	Rail Clamp	Medium	Marine-Grade Aluminum

FISHING ROD HOLDERS

RAM ROD®

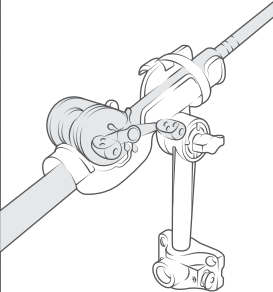
	PART NUMBER	MOUNT TYPE	BASE TYPE	HOLDER	NOTES
	RAM-114-B	Post & Spline	Bulkhead Base	RAM-114-NB	-
	BEST SELLER RAM-114-BMP	Post & Spline	Combo Bulkhead Base	RAM-114-NB	-
	RAM-114-D	Post & Spline	Deck Drill-Down Base	RAM-114-NB	-
	RAP-114-421	Post & Spline	Dual T-Bolt Track Base	RAM-114-NB	-
	RAP-114-PA-421	Post & Spline	Dual T-Bolt Track Base	-	Dual Ratchet Adjustment
	RAM-114-F	Post & Spline	Flush Base	RAM-114-NB	-
	RAM-114-RBSW	Ball & Socket w/ Ratchet	Drill-Down Ball Base	RAM-114-RBNBU	Stainless Steel Base for Saltwater
	RAM-114-RB	Ball & Socket w/ Ratchet	Drill-Down Ball Base	RAM-114-RBNBU	Marine-Grade Aluminum Base for Freshwater
	RAP-340	Ball & Socket	Drill-Down Ball Base	RAP-340NB	Low Profile
	RAP-341	Ball & Socket	Drill-Down Ball Base	RAP-341NB	Low Profile, Fly Rod Holder
	RAM-114-RB-TRA1	Ball & Socket w/ Ratchet	RAM® Track Ball™	RAM-114-RBNBU	
	RAP-340-TRA1	Ball & Socket	RAM® Track Ball™	RAP-340NB	Low Profile
	RAP-341-TRA1	Ball & Socket	RAM® Track Ball™	RAP-341NB	Low Profile, Fly Rod Holder
	RAM-117SWJ	Double Ball & Socket	Drill-Down Ball Base	RAM-117B	Stainless Steel Base for Saltwater
	RAM-117	Double Ball & Socket	Drill-Down Ball Base	RAM-117B	Marine-Grade Aluminum Base for Freshwater
	RAP-114-PA-411	Ratchet	RAM® Track-Node™ Base	-	-

RAM ROD® HD

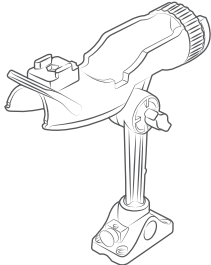
	PART NUMBER	BASE TYPE	HOLDER
	BEST SELLER RAP-433-BMP	Combo Bulkhead Base	RAP-433-NB
	RAP-433-421	Dual T-Bolt Track Base	RAP-433-NB
	RAP-433-PA-411	RAM® Track-Node™ Base	-

RAM ROD® JR

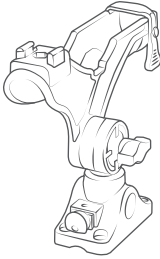
	PART NUMBER	BASE TYPE	HOLDER
	RAP-434-BMP	Combo Bulkhead Base	RAP-434-NB
	BEST SELLER RAP-434-421	Dual T-Bolt Track Base	RAP-434-NB
	RAP-434-PA-411	RAM® Track-Node™ Base	-
	RAP-434-RB-TRA1	RAM® Track Ball™	RAP-434-RBNB

RAM® TUBE™

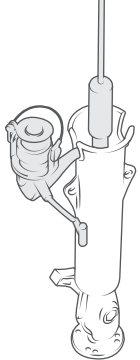
	PART NUMBER	MOUNT TYPE	BASE TYPE	HOLDER	NOTES
	RAM-119	Ball & Socket	Drill-Down Ball Base	RAM-119B	
	BEST SELLER RAM-301-BMP	Post & Spline	Combo Bulkhead Base	RAM-301-NB	
	RAM-301-B	Post & Spline	Bulkhead Base	RAM-301-NB	
	RAM-301-D	Post & Spline	Deck Drill-Down Base	RAM-301-NB	
	RAM-301-F	Post & Spline	Flush Base	RAM-301-NB	
	RAM-301-RBSW	Ball & Socket w Ratchet	Drill-Down Ball Base	RAM-301-RBNBU	Stainless Steel Base for Saltwater
	RAM-301-RB	Ball & Socket w Ratchet	Drill-Down Ball Base	RAM-301-RBNBU	Marine-Grade Aluminum Base for Freshwater
	RAP-119-TRA1	Ball & Socket	RAM® Track Ball™	RAP-119NB	
	RAP-119SW	Ball & Socket	Drill-Down Ball Base	RAP-119NB	Stainless Steel Base for Saltwater
	RAP-119	Ball & Socket	Drill-Down Ball Base	RAP-119NB	Marine-Grade Aluminum Base for Freshwater

FISHING ROD HOLDERS

RAM® TOUGH-TUBE™

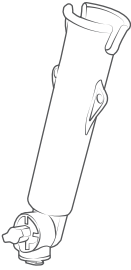
	PART NUMBER	BASE TYPE	HOLDER
	BEST SELLER RAP-394-SSBMP	Combo Bulkhead Base	RAP-394-SST
RAP-394-SSF	Flush Base	RAP-394-SST	
RAP-394-SSFMT	Flush Base - Round	RAP-394-SST	
RAP-385-12-394	Flush Tube Wedge Adapter	-	
RAP-394-418	Track Base	-	

RAM® TUBE JR.™

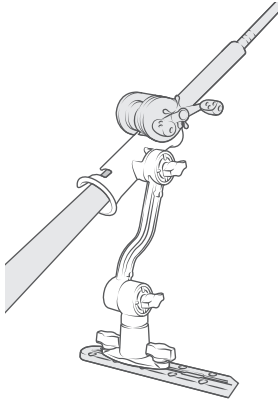
	PART NUMBER	MOUNT TYPE	BASE TYPE	POST LENGTH	HOLDER
	RAP-390-BMP	Post & Spline	Combo Bulkhead Base	6"	RAP-390U
RAP-390-SBMP	Post & Spline	Combo Bulkhead Base	3.75"	RAP-390-STU	
RAP-390-BU	Post & Spline	Bulkhead Base	6"	RAP-390U	
RAP-390-SBU	Post & Spline	Bulkhead Base	3.75"	RAP-390-STU	
RAP-390-F	Post & Spline	Flush Base	6"	RAP-390U	
RAP-390-SF	Post & Spline	Flush Base	3.75"	RAP-390-STU	
RAP-390-FMT	Post & Spline	Flush Base - Round	6"	RAP-390U	
RAP-390-SFMTU	Post & Spline	Flush Base - Round	3.75"	RAP-390-STU	
RAP-390-AAPUTU	Post & Spline	RAM® Universal Adapt-A-Post™	6"	RAP-390U	
RAP-390-SAAPUTU	Post & Spline	RAM® Universal Adapt-A-Post™	3.75"	RAP-390-STU	
RAP-390-421	Post & Spline	Dual T-Bolt Track Base	6"	RAP-390U	
RAP-390-PA-421	Post & Spline w/ Extra Ratchet	Dual T-Bolt Track Base	-	RAP-390-NPU	
RAP-390-PA-411	Ratchet	RAM® Track-Node™ Base	-	RAP-390-NPU	
RAP-390-PA-418	Ratchet	Track Base	-	RAP-390-NPU	
RAP-390-RB	Ball & Socket w/ Ratchet	Drill-Down Ball Base	-	RAP-390-RB-NBU	
BEST SELLER RAP-390-RB-TRA1	Ball & Socket w/ Ratchet	RAM® Track Ball™	-	RAP-390-RB-NBU	

RAM® POST & SPLINE COMPONENTS

BASES

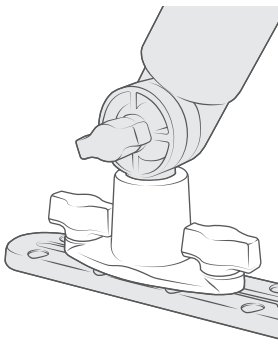
	PART NUMBER	BASE TYPE	HOLDER
	RAM-114BM	Bulkhead Drill-Down Base	-
RAP-AAPUBU	Bulkhead Drill-Down Base	RAM® Universal Adapt-A-Post™	
RAM-114BMP	Combo Bulkhead Base	-	
RAM-114FM	Flush Drill-Down Base	-	
RAM-114FMT	Flush Drill-Down Base - Round	-	
RAP-AAPUDTU	2-Hole Drill-Down Base	RAM® Universal Adapt-A-Post™	
RAM-114DTM5	4-Hole Drill-Down Base	-	
RAP-AAPUDU	4-Hole Drill-Down Base	RAM® Universal Adapt-A-Post™	
RAP-AAPUH-1U	Hobie H-Rail Adapter	RAM® Universal Adapt-A-Post™	
RAP-411-AAPU	RAM® Track-Node™ Base	RAM® Adapt-A-Post™	
RAP-AAPUTU	Track Base	RAM® Universal Adapt-A-Post™	
BEST SELLER RAP-421	Track Base - Dual T-Bolt	-	
RAP-AAPUDT-1U	Track Base - Dual T-Bolt	-	
RAP-AAPRU	Track Base - Vertical	RAM® Adapt-A-Post™	

ROD HOLDERS WITH POST

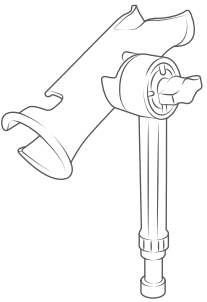
	PART NUMBER	SERIES	POST LENGTH
	BEST SELLER RAM-114-NBU	RAM ROD®	6"
RAP-394-SSTU	RAM® Tough-Tube™	2"	
RAP-390U	RAM® Tube Jr.™	6"	
RAP-390-STU	RAM® Tube Jr.™	3.75"	
RAP-433-NB	RAM ROD® HD	6"	
RAM-301-NB	RAM® Tube™	6"	
RAP-434-NB	RAM ROD® JR	2"	

POST & SPLINE ADAPTERS & EXTENSIONS

	PART NUMBER	PART TYPE	LENGTH
	RAP-114-EX6	Extension Arm - PVC Pipe	6"
	RAP-114-EX8	Extension Arm - PVC Pipe	8"
	RAP-114-EX12	Extension Arm - PVC Pipe	12"
	BEST SELLER RAP-114-APB2U	Extension Arm - Ratchet	13.5"
	RAP-114-APB3U	Extension Arm - Ratchet	16"
	RAP-B-354-419U	B Size 1" Ball Adapter	-
	RAP-B-354-75U	B Size 1" Ball Wedge Adapter	-
	RAP-354-419U	C Size 1.5" Ball Adapter	-
	RAP-354-75U	C Size 1.5" Ball Wedge Adapter	-
	RAP-114-PSPU	PVC Socket Adapter	-
	RAP-114FFRU	RAM® Flex-Rod™ Adapter	-
	RAP-114-5PU	5-Spot Post Adapter	-

TRANSDUCER MOUNTS

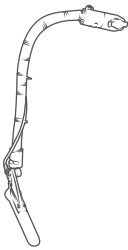
	PART NUMBER	TRANSDUCER CONNECTION	MOUNT TYPE
	RAM-B-316-18-TRA1-NB	1/4"-20 Screw	B Size 1" Socket Arm
	RAM-B-316-18-TRA1	1/4"-20 Screw	2-Hole Drill-Down Base
	RAM-B-316-18-TRA1-202-225	1/4"-20 Screw	4-Hole Drill-Down Base
	RAM-B-316-18-TRA1-354-75	1/4"-20 Screw	B Size 1" Ball Wedge Adapter
	BEST SELLER RAM-B-316-18-TRA1-TRA1	1/4"-20 Screw	RAM® Track Ball™ Base
	RAM-B-316-18-TRA2-NB	HydroWave™	B Size 1" Socket Arm
	RAM-B-316-18-TRA2	HydroWave™	2-Hole Drill-Down Base
	RAM-B-316-18-TRA3-NB	Lowrance StructureScan	B Size 1" Socket Arm
	RAM-B-316-18-TRA3	Lowrance StructureScan	2-Hole Drill-Down Base
RAM-316-18-TRA4-NB	Lowrance TotalScan	C Size 1.5" Socket Arm	

CAMERA MOUNTS - RAM® TOUGH-POLE™

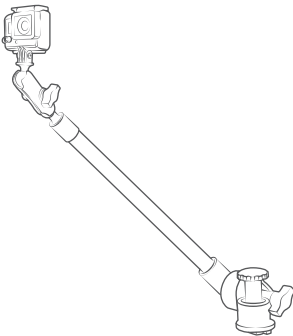
	PART NUMBER	MOUNT TYPE	BASE TYPE	OVERALL HEIGHT
	RAP-354-TRA1-12-A-GOP1	Ball & Socket	RAM® Track Ball™	22"
	RAP-425-18-A-GOP1	Fixed PVC Pipe Mount	Track Base	23"
	RAP-425-4-18-A-GOP1	Fixed PVC Pipe Mount	Track Base	33"
	RAP-425-18-18-A-GOP1	Fixed PVC Pipe Mount	Track Base	47"
	RAP-425-4-A-GOP1	Fixed PVC Pipe Mount	Track Base	9"
	RAP-114BD-4-12-A-GOP1	Post & Spline	Combo Bulkhead Base	29"
	RAP-114BD-4-12-4-A-GOP1	Post & Spline	Combo Bulkhead Base	38"
	RAP-411-18-A-GOP1	Post & Spline	Dual T-Bolt Track Base	24"
	RAP-411-18-18-A-GOP1	Post & Spline	Dual T-Bolt Track Base	48"
	RAP-411-18-A-GOP1-1	RAM® Track-Node™	Track Base	22"
	BEST SELLER RAP-411-18-18-A-GOP1-1	RAM® Track-Node™	Track Base	46"
	RAP-385-12-18-A-GOP1	Ratchet PVC Pipe	Flush Tube Wedge Adapter	24"
	RAP-385-12-18-18-A-GOP1	Ratchet PVC Pipe	Flush Tube Wedge Adapter	44"

INFLATABLE BOAT & RAFT MOUNTS

	PART NUMBER	DESCRIPTION
	RAP-398-BLK-TRACK-AU	Black RAM® Bond-A-Base™ with RAM® Tough-Track™
	RAP-398-BLK-202U	Black RAM® Bond-A-Base™ with C Size 1.5" Ball Base
	BEST SELLER RAP-398-BLK-114BMPU	Black RAM® Bond-A-Base™ with Post/Spline Combo Bulkhead Base
	RAP-B-399U	Strap Adapter with B Size 1" Ball
	RAP-399U	Strap Adapter with C Size 1.5" Ball
	RAP-398-GRY-TRACK-AU	Grey RAM® Bond-A-Base™ with RAM® Tough-Track™
	RAP-398-GRY-202U	Grey RAM® Bond-A-Base™ with C Size 1.5" Ball Base
	RAP-398-GRY-114BMPU	Grey RAM® Bond-A-Base™ with Post/Spline Combo Bulkhead Base

RAM® TOUGH-TRACK™

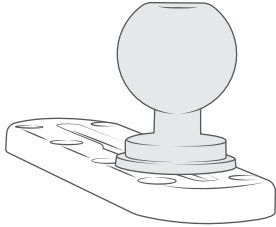
	PART NUMBER	MOUNT TYPE	OVERALL LENGTH	CLAMP RANGE
	RAP-TRACK-A2	Drill-Down	3.75"	-
	RAP-TRACK-A3	Drill-Down	4.75"	-
	RAP-TRACK-A5	Drill-Down	7"	-
	RAP-TRACK-A9	Drill-Down	10.75"	-
	RAP-TRACK-A12	Drill-Down	14.5"	-
	RAP-TRACK-A16	Drill-Down	18.5"	-
	RAP-400-TRACKU	RAM® Tough-Claw™ Rail System	12"	.625" - 1.5" Diameter
	RAP-404-TRACKU	RAM® Tough-Claw™ Rail System	12"	1" - 1.875" Diameter
	RAP-401-TRACKU	RAM® Tough-Claw™ Rail System	12"	1" - 2.25" Diameter
	RAP-TRACK-B12HU	U-Bolt Rail System	12"	1.75" - 2" Diameter
	RAP-TRACK-B12U	U-Bolt Rail System	12"	.625" - 1.25" Diameter
	RAP-TRACK-B18HU	U-Bolt Rail System	18"	1.75" - 2" Diameter
	RAP-TRACK-B18U	U-Bolt Rail System	18"	.625" - 1.25" Diameter
	RAP-TRACK-B7HU	U-Bolt Rail System	7"	1.75" - 2" Diameter
RAP-TRACK-B7U	U-Bolt Rail System	7"	.625" - 1.25" Diameter	

RAM® HAND-TRACK™

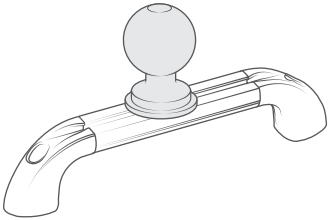
	PART NUMBER	TRACK TYPE	OVERALL LENGTH	INSIDE TRACK LENGTH
	RAM-TRACK-H12	Complete Track	18"	12"
	RAM-TRACK-H4		10"	4"
	RAM-TRACK-H6		12"	6"
	RAM-TRACK-H8		14"	8"
	RAM-TRACK-H10		16"	10"
	RAM-TRACK-H15		21"	15"
	BEST SELLER RAM-TRACK-H18	24"	18"	
	RAM-TRACK-H30	36"	30"	
	RAM-TRACK-HC-4	Track Extension	-	4"
	RAM-TRACK-HC-6		-	6"
	RAM-TRACK-HC-8		-	8"
	RAM-TRACK-HC-10		-	10"
	RAM-TRACK-HC-12		-	12"
	RAM-TRACK-HC-15		-	15"
	RAM-TRACK-HC-18		-	18"
	RAM-TRACK-HC-30U		-	30"

MODULAR ALUMINUM TRACKS

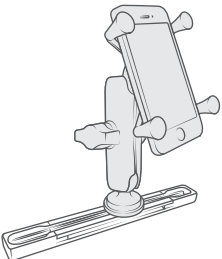
	PART NUMBER	OVERALL LENGTH	INSIDE TRACK LENGTH	COLOR	DESCRIPTION
	RAM-TRACK-EXA-3BU	6"	3"	Black	-
	RAM-TRACK-EXA-3	6"	3"	Chrome	-
	RAM-TRACK-EXA-5BU	8"	5"	Black	-
	RAM-TRACK-EXA-5	8"	5"	Chrome	-
	BEST SELLER RAM-TRACK-EXA-9BU	12"	9"	Black	-
	RAM-TRACK-EXA-9	12"	9"	Chrome	-
	RAM-TRACK-EXA-13BU	16"	13"	Black	-
	RAM-TRACK-EXA-13	16"	13"	Chrome	-
	RAM-TRACK-EXA-17BU	20"	17"	Black	-
	RAM-TRACK-EXA-17	20"	17"	Chrome	-
	RAP-TRACK-EXA-CCU	-	-	-	Straight Track Extension Connector
	RAP-TRACK-EXA-CC90U	-	-	-	90-Degree Track Extension Connector



rammount.com
1.800.497.7479
sales@rammount.com



IntelliSkin®



GDS®
TECH™

GDS®, IntelliSkin®, GDS® Tech™, GDS® Technology™, GDS® Green™, GDS® Reach™, and GDS® Compatible™ are trademarks or registered trademarks of National Products Inc.

The distinctive D Shape™ of the GDS® connector is a trademark of National Products Inc.

PATENTS AND TRADEMARKS
WWW.RAMMOUNT.COM/IP



RAM® double socket arms with their distinctive Hourglass Shape are recognized globally as a symbol of the reliability, quality, and durability of this line of products. The Hourglass Shape is a registered trademark of National Products Inc.



The distinctive RAM® "X-Grip®" product shape is a trademark of National Products Inc.



Look for the highly recognizable "Double Delta" trademark, the symbol of quality and reliability

