



RAM[®]
MOUNTS

Bicycle



SEEN IN THIS PHOTO:

RAM-B-202-GA76U

RAM® Spine Clip Holder with Ball for Garmin Handheld Devices

RAM-B-201U-A

RAM® Double Socket Arm

RAP-B-460U

RAM® Tough-Strap™ Handlebar Ball Base



TABLE OF CONTENTS

03 NEW PRODUCTS

05 ABOUT RAM® MOUNTS

07 HOW IT WORKS

09 RAM® TOUGH-STRAP™

- 09 RAM® TOUGH-STRAP™ + RAM® X-GRIP®
 - 11 RAM® TOUGH-STRAP™ + DOUBLE BALL MOUNTS
-

13 RAM® TOUGH-CLAW™

- 13 RAM® TOUGH-CLAW™ + RAM® X-GRIP®
 - 15 RAM® TOUGH-CLAW™ + GPS MOUNTS
 - 17 RAM® TOUGH-CLAW™ BASE OPTIONS
-

19 RAM® TORQUE™

21 ACTION CAMERA MOUNTS

23 RAM® EZ-ON/OFF™

- 23 RAM® EZ-ON/OFF™ + RAM® X-GRIP®
 - 25 RAM® EZ-ON/OFF™ + GPS MOUNTS
-

27 RAM® EZ-STRAP™

- 27 RAM® EZ-STRAP™ TOP SOLUTIONS
-

29 RAM® LEVEL-CUP™

31 BASE COMPARISON CHART

33 THE SHAPE THAT STARTED IT ALL

SEEN IN THIS PHOTO:

RAP-B-460-A-PD3U

RAM® Quick-Grip™ Phone Mount with
RAM® Tough-Strap™ Handlebar Base



NEW PRODUCTS



RAP-B-460U
RAM® Tough-Strap™ Handlebar
Ball Base



RAP-B-460-A-GOP1U
RAM® Tough-Strap™ Double Ball
Mount with Universal Action
Camera Adapter



RAP-B-460-A-PD3U
RAM® Quick-Grip™ Phone Mount with
RAM® Tough-Strap™ Handlebar Base



RAP-B-460-A-PD4U
RAM® Quick-Grip™ XL Phone Mount
with RAM® Tough-Strap™
Handlebar Base



RAP-460-UN7U
RAM® X-Grip® Phone Mount with
RAM® Tough-Strap™
Handlebar Base



RAP-460-UN10U
RAM® X-Grip® Large Phone Mount
with RAM® Tough-Strap™
Handlebar Base



RAP-460Z-UN7U
RAM® X-Grip® Phone Mount with Low
Profile Zip Tie Handlebar Base



RAP-460Z-UN10U
RAM® X-Grip® Large Phone Mount
with Low Profile Zip Tie
Handlebar Base

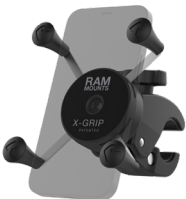

RAM-HOL-UN7-400-2U
RAM® X-Grip® Phone Mount with
Low-Profile RAM® Tough-Claw™



RAM-HOL-UN10-400-2U
RAM® X-Grip® Large Phone Mount
with Low-Profile RAM® Tough-Claw™

 VISIT RAMMOUNT.COM/NEW TO SEE ALL NEW RAM® AND GDS® PRODUCTS



ABOUT RAM® MOUNTS

RAM® Mounts manufactures rugged and versatile mounting systems for phones, tablets, and other mobile devices that can be attached nearly anywhere. Unlike other mounts on the market, RAM® allows you to secure devices where you need them most. The unique design of the RAM® Mounts system provides quick installation, adjustability, strength, vibration damping, and durability—all at a low cost. Backed by a lifetime warranty, RAM® uses powder-coated, marine-grade aluminum with lightweight and high-strength composites, stainless steel hardware, and rubber balls.

THE RAM® DIFFERENCE



PREMIUM DESIGN

The rubber ball and socket design of our mounting systems offers a secure hold, with near-infinite adjustability and vibration damping for the most demanding environments. With thousands of components trusted by users around the world, we've been able to design and develop mounting solutions that consumers and companies previously only dreamed were possible.

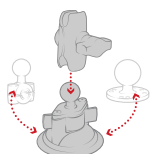

CUSTOMIZABLE

Take your phone mount from your truck to your boat, or mix and match components to create your ideal mount. Because of the modularity of the RAM® system, you can customize your solution to fit your specific needs in almost any application.

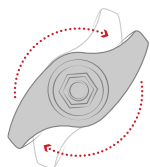

QUALITY MATERIALS

A premium design deserves the highest quality materials available, from rubber and stainless steel to high-strength composites and marine-grade aluminum. Our facilities—including powder coating, die casting, rubber injection molding, and shock and vibration testing—help us deliver on this promise to bring you inventive mounting solutions.

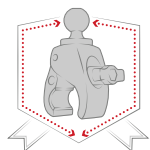

LIFETIME WARRANTY

It's simple. Our reputation as the leader of premier mounting systems means if we build it, then we guarantee it. We're confident in the quality of our products, and with our warranty, you can be too.

NATIONAL PRODUCTS INC. (NPI)

Introduced in 1995, National Products Inc. (NPI) quickly became the leading manufacturer of rugged and versatile mounting solutions. RAM® Mounts has grown to offer approximately 5,000 modular components—the most innovative product line of its kind for nearly any application and device, including phones, tablets, GPS systems, laptops, marine electronics, printers, radios, and much more.

In addition to RAM® Mounts, NPI is also the creator of award-winning IntelliSkin® sleeves and GDS® Technology™ products. IntelliSkin® sleeves ruggedize a wide range of consumer phones and tablets, while the GDS® Ecosystem™ provides users the ability to securely charge, dock, and sync devices in the most demanding environments.

NPI is proudly located in Seattle, Washington in the same neighborhood where the company was started.

PARTNER WITH RAM® MOUNTS

Here at RAM® Mounts, we believe that unfathomable things are possible with ingenuity. With a portfolio of more than 5,000 SKUs paired with innovative engineers and in-house product experts, we have the tools and expertise needed to create solutions that you didn't know were possible. We have the ability to solve your mounting challenges quickly, efficiently, and cost effectively.

HOW IT WORKS

DOUBLE BALL MOUNTS

Choose from a selection of holders, socket arms and ball bases to build a custom mount for your specific needs. Additional bases may be chosen so that your mount can support multiple devices, or can be transferred to alternate mounting locations.

1

CHOOSE A HOLDER

RAM® offers a wide selection of holders for your specific device.

2

CHOOSE AN ARM

Select an arm based on your desired length and placement.

3

CHOOSE A BASE

Select from a variety of bases to help secure your device where you need it.

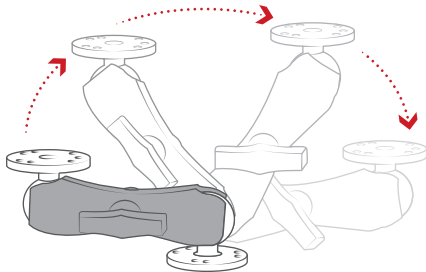
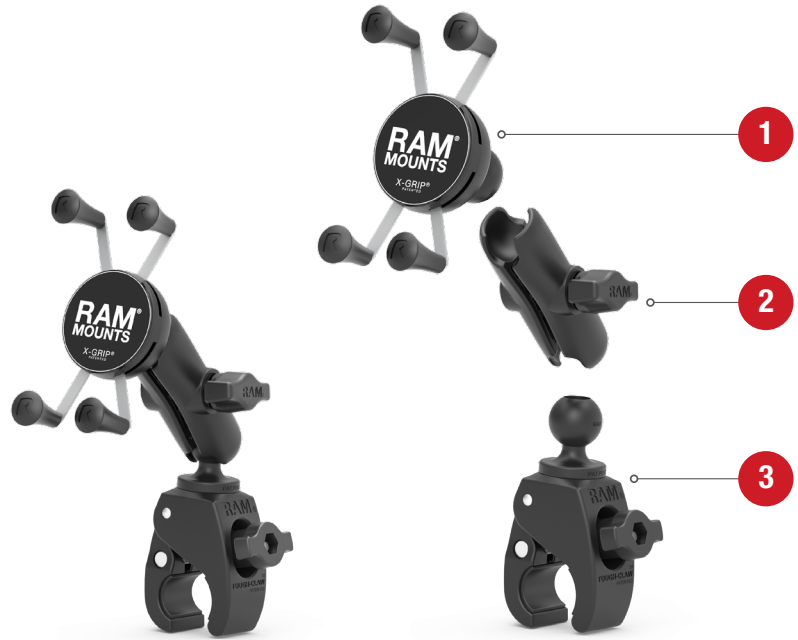

Double ball and socket technology allows for near-infinite adjustability of your RAM® mounting system

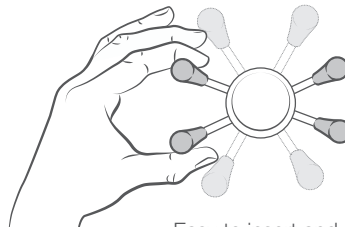

Easy to insert and remove your device

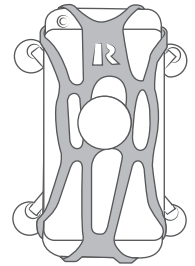

Includes safety tether for extra peace of mind

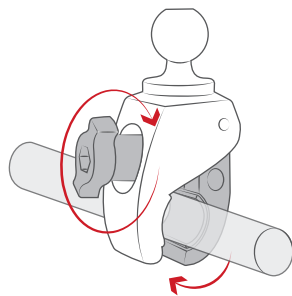

Quick Release - No Tools Required

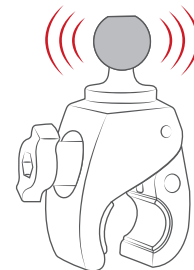

Vibration damping

1 HOLDERS



RAM-HOL-UN7BU
Small Phone Holder



BEST SELLER

RAM-HOL-UN10BU
RAM® X-Grip® for Large Phones



RAM-B-202-GA76U
RAM® Spine Clip Holder with Ball for Garmin Handheld Devices



RAP-B-202U-GOP1
RAM® Action Camera Universal Ball Adapter



RAM-HOL-PD4-238AU
RAM® Quick-Grip™ XL Holder

2 SOCKET ARMS



RAM-B-201U-A
2.42" Short Socket Arm



RAM-B-201U
3.73" Medium Socket Arm



RAM-B-201U-C
6" Long Socket Arm

3 BASES



RAP-B-460U
RAM® Tough-Strap™ Handlebar Ball Base



RAM-B-231ZU
RAM® Handlebar U-Bolt Base for Rails 0.5" to 1.25" in Diameter



RAP-B-400U
RAM® Tough-Claw™ Small Clamp Base with Ball



RAM-B-408-75-1U
.75" to 1" Diameter RAM® Torque™ Base

MORE COMPONENTS AVAILABLE AT
RAMMOUNT.COM/COMPONENTS



SEEN IN THIS PHOTO:

RAP-460-UN7U

RAM® X-Grip® Phone Mount with
RAM® Tough-Strap™ Handlebar Base

RAM® TOUGH-STRAP™

RAM® TOUGH-STRAP™ + RAM® X-GRIP®

The RAM® Tough-Strap™ is lowest profile rugged mounting solution for any bike or motorcycle handlebars. With two different size straps, easily install the RAM® Tough-Strap™ on any mountain bike, road bike or e-bike with a simple twist of a knob. There are two different versions of the RAM® Tough-Strap™ that both integrate the RAM® Pin-Lock™ system for a direct, low-profile fitting. Attach either a RAM® ball adapter for utilizing B size components to build your own device mount, or a RAM® X-Grip® phone holder directly to the strap. The long strap is used for bar diameters ranging from 1.25"-1.38" while the short strap is used for diameters ranging from 0.875"-1". Included are extra rubber strips to cut down to the diameter range of 1"-1.125" for a more custom fit that adds additional friction. Take the RAM® Tough-Strap™ on your next adventure on and off the road

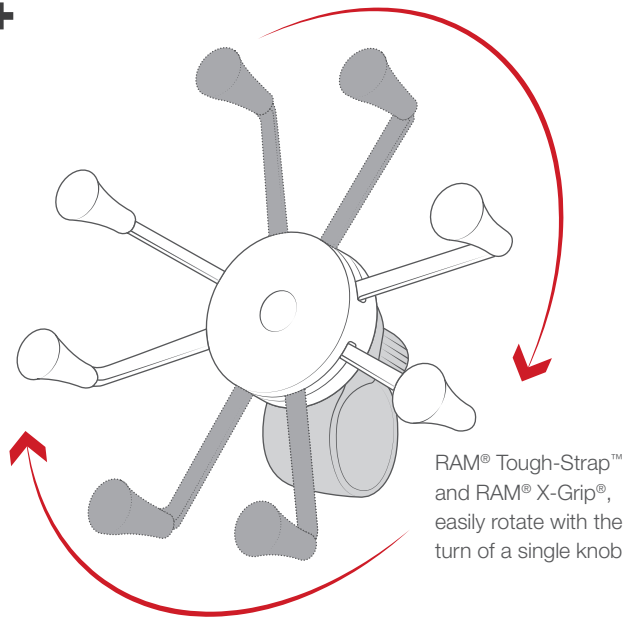

RAP-460-UN7U
RAM® X-Grip® Phone Mount with RAM® Tough-Strap™ Handlebar Base



RAP-460-UN10U
RAM® X-Grip® Large Phone Mount with RAM® Tough-Strap™ Handlebar Base

FEATURES

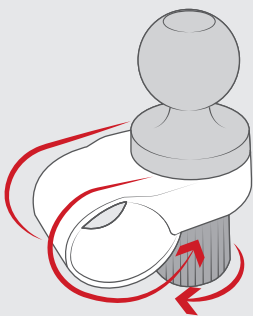

Quick Release - No Tools Required

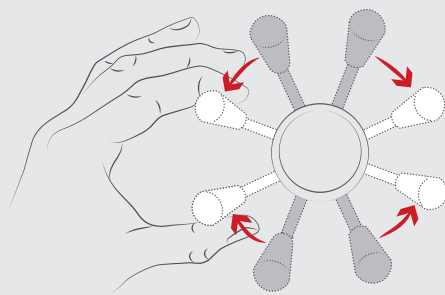

Spring-loaded 'X' design with rubber caps provides a secure fit

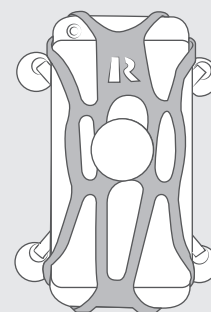

Includes safety tether for extra peace of mind



SEEN IN THIS PHOTO:

RAP-B-460-A-GOP1U

RAM® Tough-Strap™ Double Ball
Mount with Universal Action
Camera Adapter

RAM® TOUGH-STRAP™ + DOUBLE BALL MOUNTS

The RAM® Tough-Strap™ comes equipped with an integrated RAM® Pin-Lock™ adapter used to install a ball adapter for utilizing B size components to build your own device mount. Attaching a B size socket arm gives you 360-degree articulation ideal for GoPro mounting and crowded handlebars to give you a custom fit. Build your own device mount, or select popular phone and action camera kits.

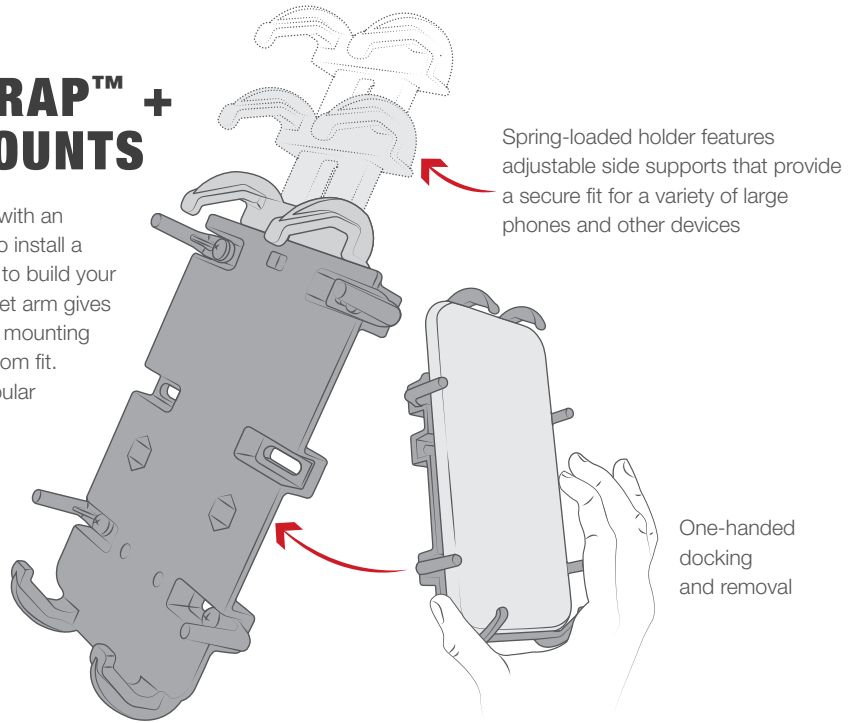

Spring-loaded holder features adjustable side supports that provide a secure fit for a variety of large phones and other devices

One-handed docking and removal



RAP-B-460U
RAM® Tough-Strap™
Handlebar Ball Base



RAP-B-460-A-PD3U
RAM® Quick-Grip™ Phone
Mount with RAM® Tough-Strap™
Handlebar Base



RAP-B-460-A-PD4U
RAM® Quick-Grip™ XL Phone
Mount with RAM® Tough-Strap™
Handlebar Base



RAP-B-460-A-GOP1U
RAM® Tough-Strap™ Double
Ball Mount with Universal Action
Camera Adapter

FEATURES

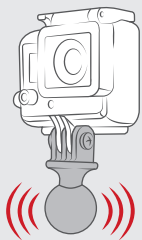

Rubber ball dampens shock and vibration

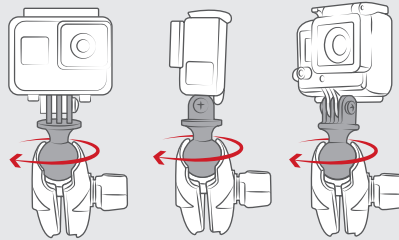

Adjustable position of camera with the turn of a single knob

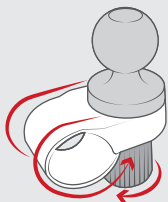

Quick Release - No Tools Required

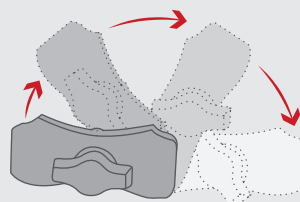

Double ball and socket technology allows for near-infinite adjustability of your RAM® mounting system

SEEN IN THIS PHOTO:

RAM-HOL-UN7-400-2U

RAM® X-Grip® Phone Mount with
Low-Profile RAM® Tough-Claw™



FEATURES

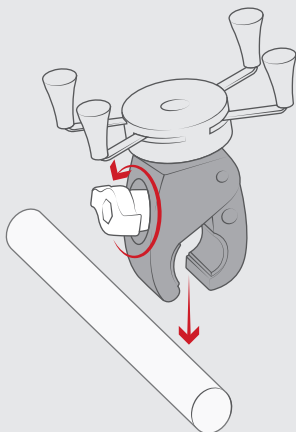

Quick Release - No Tools Required

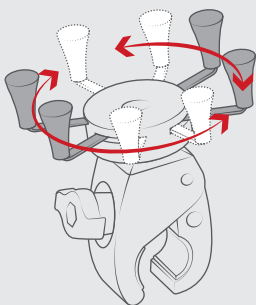

Easily positions the RAM® X-Grip® between portrait and landscape mode

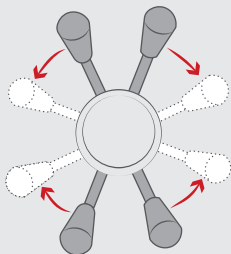

Spring-loaded 'X' design with rubber caps provides a secure fit

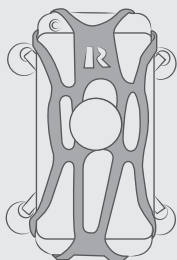

Includes safety tether for extra peace of mind

RAM® TOUGH-CLAW™

RAM® TOUGH-CLAW™ + RAM® X-Grip®

Combining the RAM® X-Grip™ holder and the RAM® Tough-Claw™ makes the ideal low profile phone mount for all types of handlebars, rails and tubes. For those who don't need too much articulation from any of RAM®'s socket arm configurations, this mounting solution is easy and straightforward, allowing you to quickly install or remove your device from it's mounting surface

BEST SELLER



RAM-HOL-UN7-400-2U

RAM® X-Grip® Phone Mount with Low-Profile RAM® Tough-Claw™



RAM-HOL-UN10-400-2U

RAM® X-Grip® Large Phone Mount with Low-Profile RAM® Tough-Claw™



RAM-HOL-UN7-400U

RAM® X-Grip® Phone Mount with RAM® Snap-Link™ Tough-Claw™



RAM-HOL-UN10-400U

RAM® X-Grip® Large Phone Mount with RAM® Snap-Link™ Tough-Claw™



RAM-B-400-A-HOL-UN7BU

RAM® X-Grip® Phone Mount with RAM® Tough-Claw™ Small Clamp Base



RAM-B-400-A-HOL-UN10BU

RAM® X-Grip® Large Phone Mount with RAM® Tough-Claw™ Small Clamp Base

SEEN IN THIS PHOTO:

RAM-B-400-SP06U
RAM® Tough-Claw™ Small
Clamp Mount for SPOT Gen4



RAM® TOUGH-CLAW™ + GPS MOUNTS

One of the best benefits of the RAM® Tough-Claw™ is the easy installation and removal on railings. Paired with a GPS mount, you can attach almost anywhere on your bike so you can travel safely. Don't feel like attaching to your handlebars? You can install these RAM® Tough-Claw™ GPS kits to any railing so you can still take advantage of using a GPS on your adventure without crowding your handlebars. From Garmin to TomTom, RAM® Mounts has low-profile and ultra-lightweight holders for just about any GPS device. Grab our Garmin spine adapter compatible holder for any Garmin device with a spine adapter for a super secure fit without interfering with any buttons or ports.

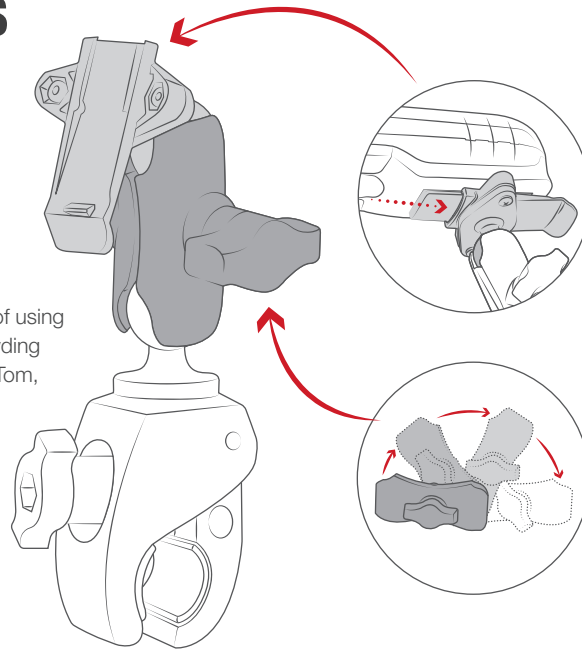

Holder secures any Garmin handheld device with an integrated spine connection

This socket technology allows for almost infinite adjustment and perfect viewing angles.



RAM-B-400-GA55U

RAM® Tough-Claw™ Small Clamp Mount for Garmin nuvi 52, 54, 55, 56 & 58



RAM-B-400-SP06U

RAM® Tough-Claw™ Small Clamp Mount for SPOT Gen4



RAP-B-400-A-MA15U

RAM® EZ-Roll'r w/ RAM® Tough-Claw™ for Magellan eXplorist + More



RAM-B-400-GA76U

RAM® Tough-Claw™ Small Clamp Mount with Garmin Spine Clip Holder

FEATURES

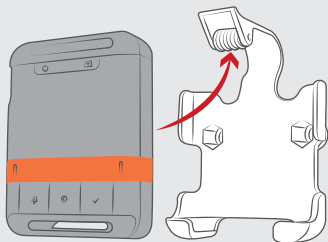

Simply slide your SPOT Gen4™ into the cradle and roll the top clip over the device to secure into place.

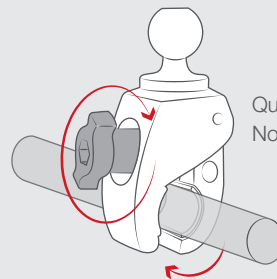

Quick Release - No Tools Required



SEEN IN THIS PHOTO:

RAM-B-404U

RAM® Tough-Claw™ Medium Clamp Base
with Ball

RAM-B-201U-A

RAM® Double Socket Arm

RAP-B-202U-GOP1

RAM® Action Camera Universal Ball Adapter

FEATURES

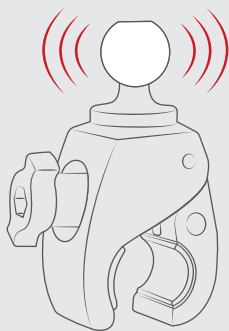

Rubber ball dampens shock and vibration

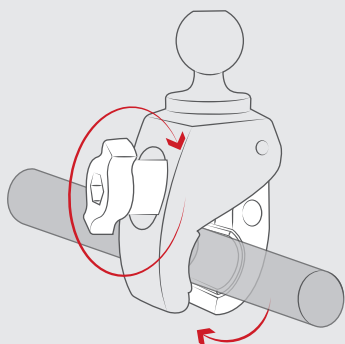

Quick Release - No Tools Required

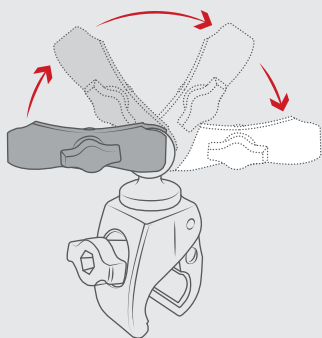

Double ball and socket technology allows for near-infinite adjustability of your RAM® mounting system

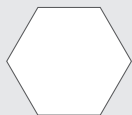

Compatible with round or odd-shaped rails

RAM® TOUGH-CLAW™ CONTINUED

RAM® TOUGH-CLAW™ BASE OPTIONS

The RAM® Tough-Claw™ is the easiest mounting base to install and remove on railings and tubes, covering a wide diameter range. This base comes in B, or C size, for both light and heavy duty riding, as well as three different claw sizes covering 0.625" to 2.25" diameter railings and tubes. With a simple tightening of the knob, these claws are truly tough clamping onto the surface without any tools necessary.



RAP-B-400U
.625" - 1.5" Diameter



RAP-B-404U
1" - 1.875" Diameter



RAP-B-401U
1" - 2.25" Diameter



RAP-B-400-201-AU
Small Clamp Base with Small Double Socket Arm, 0.625" - 1.5" Diameter



RAP-B-400-201U
Small Clamp Base with Medium Double Socket Arm, 0.625" - 1.5" Diameter



RAP-B-404-201U
Medium Clamp Base with Medium Double Socket Arm, 1" - 1.875" Diameter

SEEN IN THIS PHOTO:

RAM-HOL-PD4U

RAM® Quick-Grip™ XL Large Phone Holder

RAM-B-408-112-15-A-238U

RAM® Torque™ Large Rail Base with Diamond Plate



FEATURES

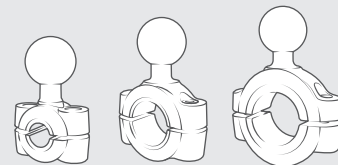
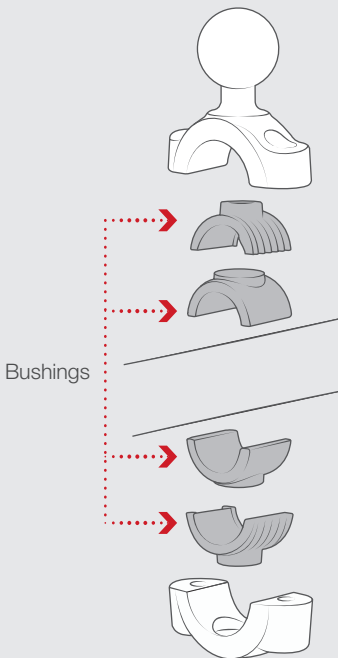

Various sizes to support rails from .375" to 1.5" in diameter



Included rubber strip offers additional friction

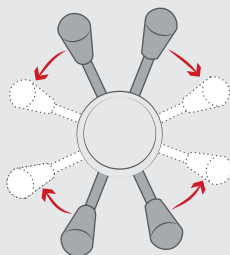

Spring-loaded 'X' design with rubber caps provides a secure fit

RAM® TORQUE™

RAM® Mounts Torque™ bases come in multiple sizes that fit a variety of rail and bar sizes for secure placement of your device. Sizing inserts create a tight hold while protecting the bar, and the cast aluminum mount is available with a B size 1" or C size 1.5" rubber ball that attaches to a RAM® double socket arm. Mount your GPS unit, camera, phone or tablet to your bike's handlebars.

Internal bushings conform to your handlebar while protecting the surface

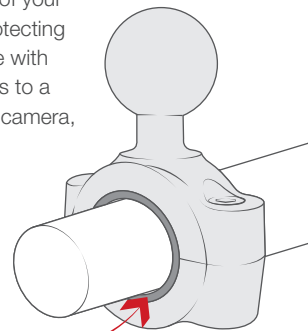

		
RAM-B-408-37-62U RAM® Torque™ Small Rail Base	RAM-B-408-75-1U .75" to 1" Diameter RAM® Torque™ Base	RAM-B-408-112-15U 1.125" to 1.5" Diameter RAM® Torque™ Base
		
RAM-B-408-75-1-A-UN7U RAM® X-Grip® Phone Mount with RAM® Torque™ Medium Rail Base	RAM-B-408-75-1-A-UN10 RAM® X-Grip® Large Phone Mount with RAM® Torque™ Medium Rail Base	RAM-B-408-75-1-A-238U RAM® Torque™ Medium Rail Base with Diamond Plate
		
RAM-B-408-75-1-A-132U RAM® Level Cup™ 12 - 16oz Drink Holder with RAM® Torque™ Medium Rail Base	RAM-B-408-75-1-A-417U RAM® Level Cup™ XL 12 - 32oz Drink Holder with RAM® Torque™ Medium Rail Base	RAM-B-408-75-1-A-GOP1U RAM® Torque™ Medium Rail Base with Universal Action Camera Adapter

SEEN IN THIS PHOTO:

RAP-B-400-GOP1U

RAM® Tough-Claw™ Double Ball Mount with
Universal Action Camera Adapter



FEATURES

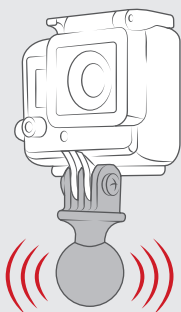

Rubber ball dampens shock and vibration

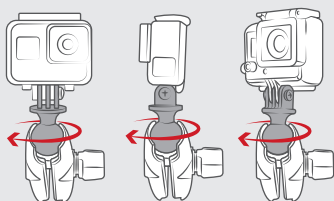

Adjustable position of camera with the turn of a single knob

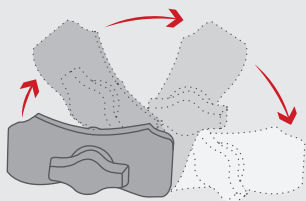

Double ball and socket technology allows for near-infinite adjustability of your RAM® mounting system

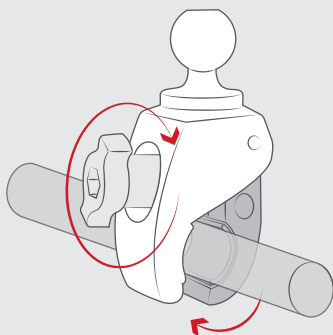

Quick Release - No Tools Required

ACTION CAMERA MOUNTS

The versatility of the RAM® Tough-Claw™ pairs the best with action camera mounting. Grab a universal action camera adapter and your preferred action camera to attach almost anywhere on your bike. Want to capture video footage from behind? Clamp to the back of your seat for a low-profile view for an epic rear tire shot.



RAP-B-400-GOP1U
RAM® Tough-Claw™ Double Ball Mount with Universal Action Camera Adapter



RAM-B-400-A-366U
RAM® Tough-Claw™ Small Clamp Mount with 1/4"-20 Action Camera Adapter



RAP-B-400-A-GOP1U
RAM® Tough-Claw™ Small Clamp Mount with Universal Action Camera Adapter



RAP-B-GOP2-A-GOP1U
RAM® Ball Adapter for GoPro® Bases with Universal Action Camera Adapter



RAP-B-202U-GOP1
RAM® Action Camera Universal Ball Adapter



RAP-B-202U-GOP2
RAM® Ball Adapter for GoPro® Mounting Bases

SEEN IN THIS PHOTO:

RAP-274-1-UN7U

RAM® X-Grip® Phone Mount with
RAM® EZ-On/Off™ Bicycle Base



RAM® EZ-ON/OFF™

RAM® EZ-ON/OFF™ + RAM® X-GRIP®

The RAM® EZ-ON/OFF™ bike mount utilizes a single RAM® Pin-Lock™ base to attach an X-Grip® phone holder directly to your handlebars for the lowest-profile solution around. To keep the mount lightweight, two zip ties loop through the bottom of the base to easily secure to your handlebar. Included is a rubber pad to add extra friction and provide a soft barrier to prevent scratching. Adjust the zip ties for attachment to a variety of rails, from a minimum of .5" in diameter. For rugged applications, the RAM® X-Grip® includes a device tether that is recommended for added security and peace of mind.

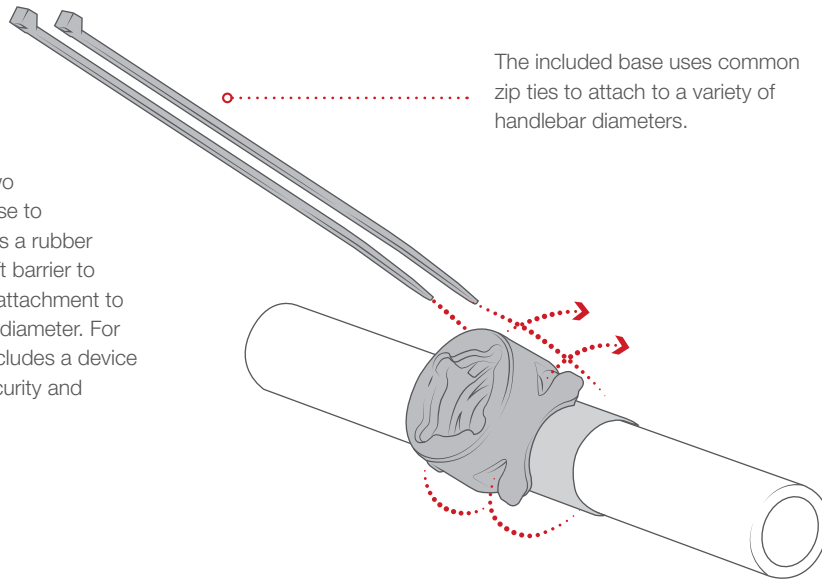

The included base uses common zip ties to attach to a variety of handlebar diameters.

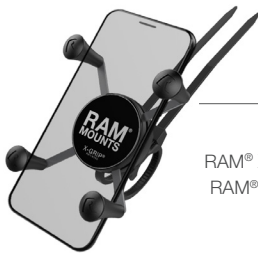

RAP-274-1-UN7U
RAM® X-Grip® Phone Mount with
RAM® EZ-On/Off™ Bicycle Base



RAP-274-1-UN10
RAM® X-Grip® Large Phone
Mount with RAM® EZ-On/Off™
Bicycle Base

FEATURES

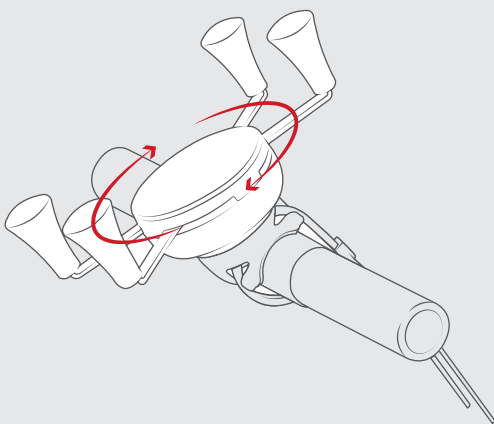

Easily positions the RAM® X-Grip® between portrait and landscape mode

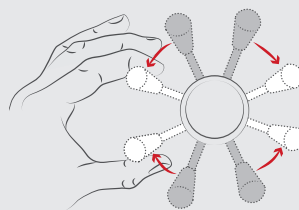

The X-Grip® has a clean and clever four leg design that sports great holding power, but also allows for easy insertion or release of your phone.



Includes safety tether for extra peace of mind

SEEN IN THIS PHOTO:

RAP-274-1-GA31U

RAM® EZ-On/Off™ Bicycle Mount for Garmin
Approach G5, Oregon 200 + More



FEATURES

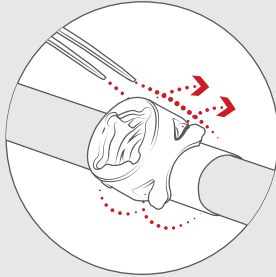
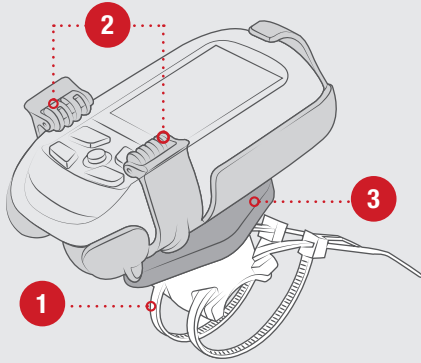

- 1** Adjust the zip ties to attach to any rail from 0.5" to 1.5" in diameter.

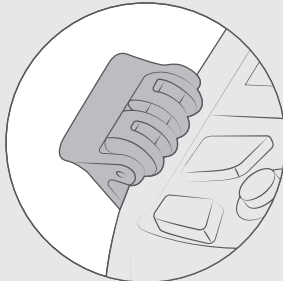

- 2** Secures your device into place by simply sliding your device into the cradle and rolling the clips over it.

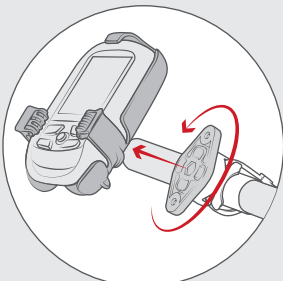

- 3** By simply pressing and twisting the diamond adapter, the EZ-On/Off system allows for the quick release of the device cradle from the zip tie base.

RAM® EZ-ON/OFF™ CONTINUED

RAM® EZ-ON/OFF™ + GPS MOUNTS

The RAM® EZ-ON/OFF™ bike mount also comes equipped with compatible GPS holders for long distance biking, or mountain biking out in the middle of nowhere. Don't get lost on the trail without navigation. This ultra-lightweight and low-cost mounting solution is an easy addition to your bike while you focus on the adventure.



RAP-274-1BFU
RAM® EZ-On/Off™ Rubber Adapter and Ties



RAP-274-1-GA40
RAM® EZ-On/Off™ Bicycle Mount for Garmin GPSMAP 73, 78, 78S, 78SC



RAP-274-1-GA41U
RAM® EZ-On/Off™ Bicycle Mount for Garmin Astro 320, GPSMAP 62 + More



RAP-274-1-GA16
RAM® EZ-On/Off™ Bicycle Mount for Garmin Vista + More



RAP-274-1-GA31U
RAM® EZ-On/Off™ Bicycle Mount for Garmin Approach G5, Oregon 200 + More



RAP-274-1-SP02U
RAM® EZ-On/Off™ Bicycle Mount for SPOT IS™ Satellite GPS Messenger



RAP-274-1-MA15U
RAM® EZ-On/Off™ Bicycle Mount for Magellan eXplorist GC, 110, 310 & 350H

SEEN IN THIS PHOTO:

RAP-SB-187-UN7U

RAM® X-Grip® Phone Mount with
RAM® EZ-Strap™ Rail Mount



FEATURES

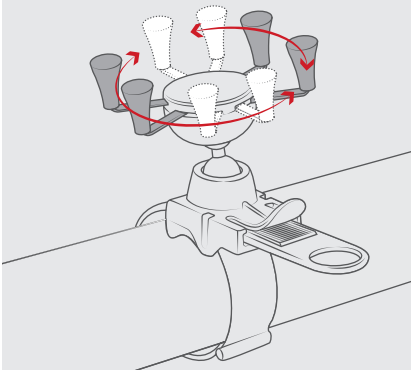

Multiple adjustment points allow you to move the universal X-Grip® cradle to your optimum viewing position. This mount rotates 180 degrees

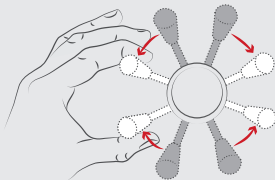

Spring-loaded 'X' design with rubber caps provides a secure fit

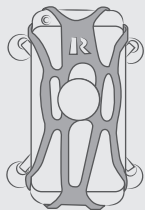

Includes safety tether for extra peace of mind

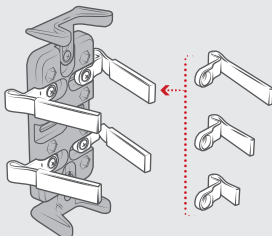

Different finger sizes to accommodate different device thicknesses

RAM® EZ-STRAP™

RAM® EZ-STRAP™ TOP SOLUTIONS

The RAM® EZ-Strap™ consists of the EZ-Strap™ base featuring a locking mechanism for attaching any RAM® Snap-Link™ Ball with a 2-hole AMPS pattern or the universal X-Grip® cradle. The strap can be cut to fit tubing, square rails and irregular shapes from 0.5" to 2.58" in diameter. Multiple adjustment points allow you to move the device holder to your optimum viewing position. This mount rotates 180 degrees.

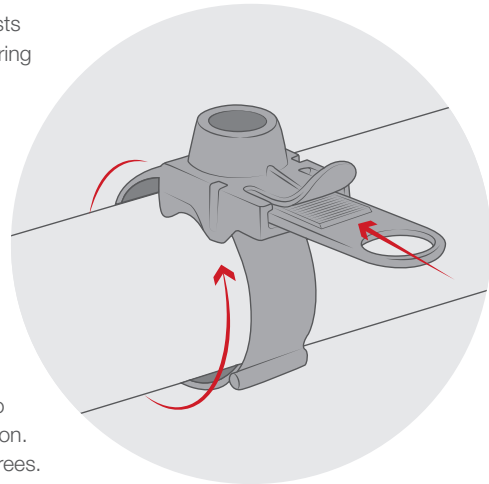

The RAM® EZ-Strap™ installs in seconds and grips tubing, square rails and irregular shapes like a Python



RAP-SB-187U
RAM® EZ-Strap™ Rail Mount with Double Ball and Diamond Base Adapter



RAP-SB-187-UN7U
RAM® X-Grip® Phone Mount with RAM® EZ-Strap™ Rail Mount



RAP-SB-187-UN4
RAM® Finger-Grip™ Universal Holder with RAM® EZ-Strap™ Rail Mount

SEEN IN THIS PHOTO:

RAM-B-132-400U

RAM® Level Cup™ 16oz Drink Holder
with RAM® Tough-Claw™ Mount



RAM® LEVEL-CUP™

Grab your Yeti and hit the road! Need an extra cup holder for your morning coffee? The RAM® Level-Cup™ is a self-leveling drink holder that comes in two sizes—16oz and 32oz. No matter how harshly you ride your bike, the Level-Cup™ self-leveling technology keeps your precious coffee in the cup and not all over the ground, or on you.

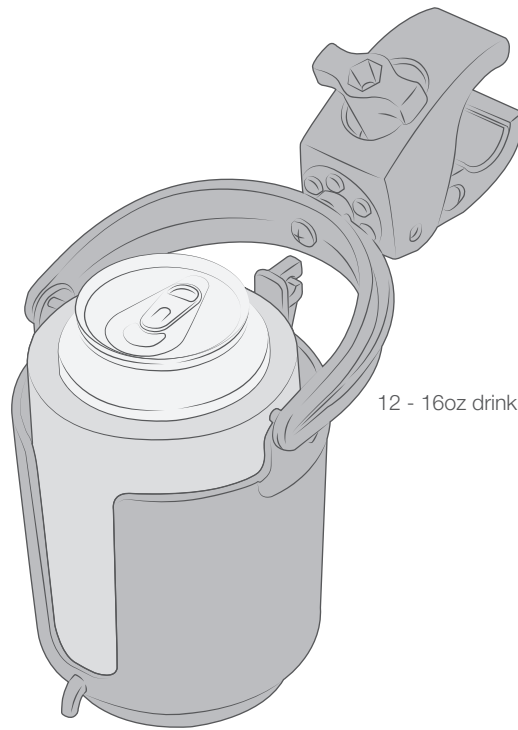

12 - 16oz drink compatibility



**BEST
SELLER**

RAP-B-417-400U

RAM® Level Cup™ XL 12 - 32oz Drink Holder with RAM® Tough-Claw™



RAM-B-132-400U

RAM® Level Cup™ 12 - 16oz Drink Holder with RAM® Tough-Claw™ Mount

FEATURES

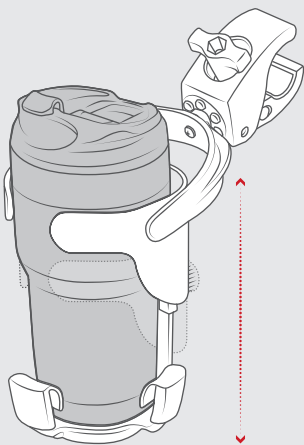

Height adjusts for 32oz holder



Self-leveling swivel mount prevents spills

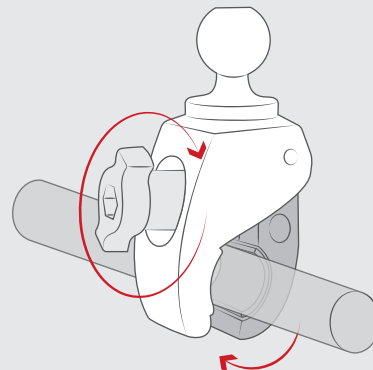

Quick Release - No Tools Required

SEEN IN THIS PHOTO:







RAP-B-460U

RAM® Tough-Strap™ Handlebar Ball Base





BASE COMPARISON CHART

					
RAP-B-460U	RAM-B-231ZU	RAM-B-408-75-1U	RAP-B-400U	RAP-274-1U	RAP-SB-187U
RAM® TOUGH-STRAP™	RAM® U-BOLT	RAM® TORQUE™	RAM® TOUGH-CLAW™	RAM® EZ-ON/OFF™	RAM® EZ-STRAP™
✓ Lifetime Warranty	✓ Lifetime Warranty	✓ Lifetime Warranty	✓ Lifetime Warranty	✓ Lifetime Warranty	✓ Lifetime Warranty
✓ Shock & Vibration Damping	✓ Shock & Vibration Damping	✓ Shock & Vibration Damping	✓ Shock & Vibration Damping	✓ Shock & Vibration Damping	✓ Shock & Vibration Damping
✓ Quick Release - No Tools Required	✓ Quick Release - No Tools Required	✗ Quick Release - No Tools Required	✓ Quick Release - No Tools Required	✗ Quick Release - No Tools Required	✓ Quick Release - No Tools Required
✓ Low Profile	✓ Low Profile	✗ Low Profile	✗ Low Profile	✓ Low Profile	✓ Low Profile
\$ Price	\$ Price	\$\$ Price	\$\$\$ Price	\$ Price	\$ Price

NEW PRODUCTS INTRO RAM® TOUGH-STRAP™ RAM® TOUGH-CLAW™ RAM® TORQUE™ ACTION CAMERA MOUNTS RAM® EZ-ON/OFF™ RAM® EZ-STRAP™ RAM® LEVEL-CUP™ BASE COMPARISON CHART

SEEN IN THIS PHOTO:

RAP-B-460U

RAM® Tough-Strap™ Handlebar Ball Base

RAP-HOL-UN4-201U

RAM® Finger-Grip™ Universal Holder with
Composite Double Socket Arm



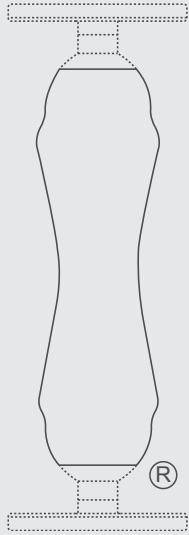

THE SHAPE THAT STARTED IT ALL

RAM® double socket arms with their distinctive Hourglass Shape are recognized globally as a symbol of the reliability, quality, and durability of this line of products. The Hourglass Shape is a registered trademark of National Products Inc.



LEARN MORE

The unique RAM® Mounts system offers a full line of interchangeable mounting bases, extensions, device adapters, and accessories to secure your devices where you want it. See all of the innovative products and solutions RAM® manufactures at rammount.com.

RAM® Mounts is a division of National Products Inc.
 8410 Dallas Avenue South
 Seattle, WA 98108
 Phone: 800.497.7479
sales@rammount.com
rammount.com

Lifetime Warranty
 Patents and Trademarks
rammount.com/ip



THE DISTINCTIVE "D" PRODUCT SHAPE

of the GDS® connector is a trademark of National Products Inc.



THE DISTINCTIVE RAM® "X-GRIP"™

product shape is a trademark of National Products Inc.



Look for the highly recognizable "Double Delta" trademark, the symbol of quality and reliability



CONTACT US
sales@rammount.com
1-800-497-7479

JOIN OUR COMMUNITY



NPI-CAT-BICYCLE21
November 2021

