



# RAM<sup>®</sup> MOUNTS

Aviation





## Local Partner

Located at Boeing Field, our next door neighbor Galvin Flying is a full service aviation company focused on flight training, aircraft maintenance, and charter flights. Not only do they have the best flight training program in the state of Washington, they integrate RAM® Mounts in nearly every aspect of their programs. From airplanes to flight simulators, Galvin relies on RAM® Mounts to securely hold devices for flight navigation, filming and in-flight note taking.





# Table of Contents

## 05 How It Works

---

## 07 iPad mini 6 Solutions

---

## 09 Tablet Holders

09 RAM® EZ-Roll'r™

11 RAM® X-Grip®

13 RAM® Tab-Tite™

---

## 15 RAM® Multi-Pad™

---

## 17 Phone Holders

17 RAM® X-Grip®

19 RAM® Quick-Grip®

21 Form-Fit Phone Holders

---

## 23 Camera Adapters

---

## 25 GPS

## 27 Sun Visor Accessory

---

## 29 Yoke Mounts

29 Cessna & Piper

31 Pilatus PC-12 NG, Beechcraft  
Bonanza & Throw Over Yokes

---

## 33 Windshield Mounting

33 RAM® Twist-Lock™ Suction Cup

35 RAM® Twist-Lock™ Suction Cup Kits

---

## 37 Kneeboard Mounts & Panel & Glare Shield Mounts

---

## 39 Commercial Aviation

---

## 41 RAM® Cessna Seat Rail Mount







# About RAM® Mounts

RAM® Mounts manufactures rugged and versatile mounting systems for phones, tablets, and other mobile devices that can be attached nearly anywhere. Unlike other mounts on the market, RAM® allows you to secure devices where you need them most. The unique design of the RAM® Mounts system provides quick installation, adjustability, strength, vibration damping, and durability—all at a low cost. Backed by a lifetime warranty, RAM® uses powder-coated, marine-grade aluminum with lightweight and high-strength composites, stainless steel hardware, and rubber balls.

## The RAM® Difference



### Premium Design

The rubber ball and socket design of our mounting systems offers a secure hold, with near-infinite adjustability and vibration damping for the most demanding environments. With thousands of components trusted by users around the world, we've been able to design and develop mounting solutions that consumers and companies previously only dreamed were possible.

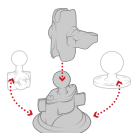

### Customizable

Take your phone mount from your truck to your boat, or mix and match components to create your ideal mount. Because of the modularity of the RAM® system, you can customize your solution to fit your specific needs in almost any application.

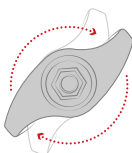

### Quality Materials

A premium design deserves the highest quality materials available, from rubber and stainless steel to high-strength composites and marine-grade aluminum. Our facilities—including powder coating, die casting, rubber injection molding, and shock and vibration testing—help us deliver on this promise to bring you inventive mounting solutions.

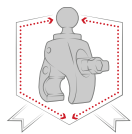

### Lifetime Warranty

It's simple. Our reputation as the leader of premier mounting systems means if we build it, then we guarantee it. We're confident in the quality of our products, and with our warranty, you can be too.

\*1-3 year warranty on electronics, including powered docks

## National Products Inc. (NPI)

Introduced in 1990, National Products Inc. (NPI) quickly became the leading manufacturer of rugged and versatile mounting solutions. RAM® Mounts has grown to offer approximately 5,000 modular components—the most innovative product line of its kind for nearly any application and device, including phones, tablets, GPS systems, laptops, marine electronics, printers, radios, and much more.

In addition to RAM® Mounts, NPI is also the creator of award-winning IntelliSkin® sleeves and GDS® Technology™ products. IntelliSkin® sleeves ruggedize a wide range of consumer phones and tablets, while the GDS® Ecosystem™ provides users the ability to securely charge, dock, and sync devices in the most demanding environments.

NPI is proudly located in Seattle, Washington in the same neighborhood where the company was started.

## Partner with RAM® Mounts

Here at RAM® Mounts, we believe that unfathomable things are possible with ingenuity. With a portfolio of more than 5,000 SKUs paired with innovative engineers and in-house product experts, we have the tools and expertise needed to create solutions that you didn't know were possible. We have the ability to solve your mounting challenges quickly, efficiently, and cost effectively.

# How It Works

## Double Socket Mounting System

Choose from a selection of holders, socket arms and ball bases to build a custom mount for your specific aircraft. Additional bases may be chosen so that your mount can support multiple devices, or can be transferred to alternate mounting locations.



1

### Choose a Holder

RAM® offers a wide selection of holders for your specific device

2

### Choose an Arm

Select an arm based on your desired length and placement

3

### Choose a Base

Select from a variety of bases to help secure your device where you need it

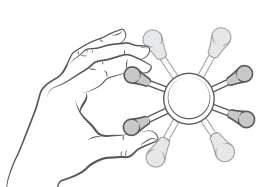

Vibration damping

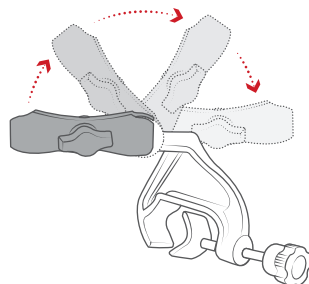

Double ball and socket technology allows for near-infinite adjustability of your RAM® mounting system

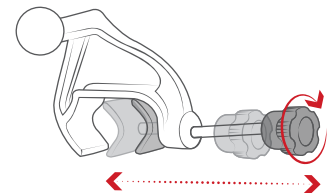

The yoke clamp base will fit rails in diameter from 0.625" to a maximum of 1.25"



How It Works Continued

**1 Choose a Holder**



**RAM-HOL-AP35U**  
RAM® Form-Fit Cradle for Apple iPhone 12 Pro Max & 13 Pro Max



**RAM-HOL-UN7BU**  
RAM® X-Grip® Universal Phone Holder with Ball



**RAM-HOL-UN10BU**  
RAM® X-Grip® Large Phone Holder with Ball



**RAM-HOL-PD3-238AU**  
RAM® Quick-Grip™ Universal Phone Holder with Ball



**RAM-B-202-AP36U**  
RAM® EZ-Roll'r™ Cradle with Ball for Apple iPad mini 6



**RAM-HOL-TAB12U**  
RAM® Tab-Tite™ Universal Spring Loaded Holder for 8" Tablets with Case

**2 Choose an Arm**

For holders with a ball



**RAM-B-201U-A**  
Short Arm



**RAM-B-201U**  
Medium Arm



**RAM-B-201U-C**  
Long Arm

For holders without a ball



**RAM-B-103-A-238U**  
Short Arm



**RAM-B-103-238U**  
Medium Arm



**RAM-B-103-C-238U**  
Long Arm

**3 Choose a Base**



**RAM-B-202U**  
Drill-Down Base



**RAM-B-121BU**  
RAM® Yoke Clamp Base with Ball



**RAM-B-189B-PIV1U**  
RAM® Twist-Lock™ Dual Pivot Suction Cup Base with Ball



**RAM-B-224-1U**  
RAM® Twist-Lock™ Suction Cup Base with Ball



**RAM-B-108B-STRAP40U**  
RAM® Large Strap Hose Clamp Base for Beechcraft Bonanza Airplanes



**RAM-B-259U**  
RAM® Glare Shield Clamp Ball Base



**RAM-B-380U**  
RAM® Yoke Clamp Base with Ball for Pilatus PC-12NG



SEEN IN THIS PHOTO:

**RAM-BM-L1-SB1-TAB2U**

RAM® Tab-Tite™ with Kneeboard  
Mount for iPad mini Series + More



## Features

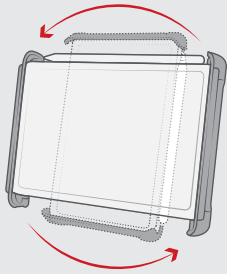

Easily position any aviation tablet mount between portrait and landscape mode

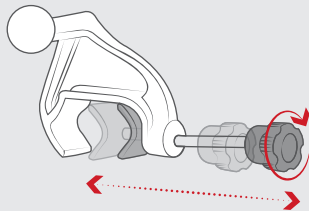

The yoke clamp base will fit rails in diameter from 0.625" to a maximum of 1.25"

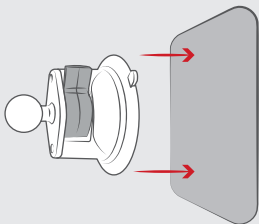

Holds strong against any windshield or non-porous surface

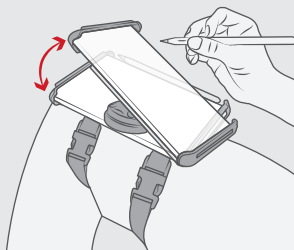

Kneboard leg mount allows easy angling of tablet to avoid sun glare

# iPad mini 6 Solutions

The newest and most exciting iPad yet just got the support it needed. RAM® Mounts carries the necessary holders for the new iPad mini 6, including the form-fitting RAM® EZ-Roll'r™ cradle, the RAM® Tab-Tite™ holder, and the RAM® X-Grip® for cased iPad mini 6's.

## Holders



No Case



**RAM-HOL-AP36U**  
RAM® EZ-Roll'r™  
Cradle for Apple  
iPad mini 6



With Thin Case or No Case



**RAM-HOL-TAB2U\***  
RAM® Tab-Tite™  
Spring Loaded  
Holder for 7" Tablets  
\* Can Charge Apple  
Pencil While in Holder



With Case



**RAM-HOL-TAB12U**  
RAM® Tab-Tite™  
Universal Spring  
Loaded Holder for  
8" Tablets w/ Case



With Case or No Case



**RAM-HOL-UN8BU**  
RAM® X-Grip®  
Universal Holder  
for 7"-8" Tablets  
with Ball

## Yoke Mounts



**RAM-B-121-AP36U**  
RAM® EZ-Roll'r™ Cradle  
with Yoke Clamp Mount



**RAM-B-121-TAB2U**  
RAM® Tab-Tite™ Yoke  
Clamp Mount



**RAM-B-121-TAB12U**  
RAM® Tab-Tite™ Yoke  
Clamp Mount for Heavy  
Duty Cases

## Suction Cup Mounts



**RAM-B-166-AP36U**  
RAM® Twist-Lock™ Suction Cup  
with EZ-Roll'r™



**RAM-B-166-TAB12U**  
RAM® Twist-Lock™ Suction Cup with  
Tab-Tite™ for Heavy Duty Cases

## Kneboard Mounts



**RAM-BM-L1-SB1-TAB2U**  
RAM® Tab-Tite™ with  
Kneboard Mount



**RAM-BM-L1-SB1-TAB12U**  
RAM® Tab-Tite™ with Kneboard  
Mount for Heavy Duty Cases



SEEN IN THIS PHOTO:

**RAM-HOL-AP36U**

RAM® EZ-Roll'r™ Cradle for Apple iPad mini 6

**RAM-B-121-202U**

RAM® Double Ball Yoke Clamp Mount with Round Plate





## Features

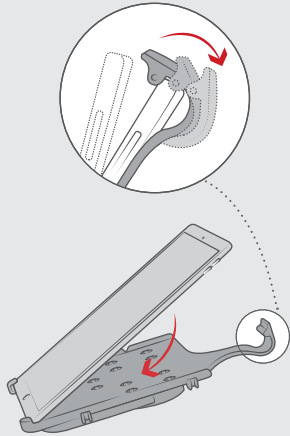

Patented roller design protects device and makes the insertion & removal of the tablet easy

Multiple hole patterns allow your iPad to be centered in portrait or landscape mode

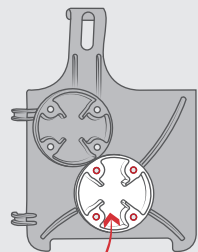
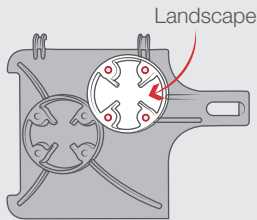

Portrait

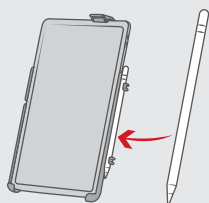

Integrated Apple Pencil holder for select models

# Tablet Holders

## RAM® EZ-Roll'r™

These form-fit holders are designed to fit your device perfectly for a low-profile mounting solution. The patented roller design allows for easy docking and removal of the tablet without fumbling around. Modified versions of these holders include combo and key-locking features for theft deterrence as well as a holder for the Apple Pencil.



**BEST  
SELLER**

**RAM-HOL-AP36U**  
RAM® EZ-Roll'r™  
Cradle for iPad mini 6



**RAM-HOL-AP23U**

RAM® EZ-Roll'r™ Cradle for Apple iPad Pro 11" (1<sup>st</sup> - 3<sup>rd</sup> Gen), Air 4 and 5



**RAM-HOL-AP31U**

RAM® EZ-Roll'r™ Cradle for Apple iPad 7<sup>th</sup>, 8<sup>th</sup> & 9<sup>th</sup> Gen



**RAM-HOL-AP24U**

RAM® EZ-Roll'r™ Cradle for Apple iPad Pro 12.9" 3<sup>rd</sup> Gen



**RAM-HOL-AP22U**

RAM® EZ-Roll'r™ Cradle for Apple iPad Air 3 & iPad Pro 10.5



**RAM-HOL-AP20U**

RAM® EZ-Roll'r™ Cradle for Apple iPad mini 4 & 5



**RAM-HOL-AP21U**

RAM® EZ-Roll'r™ Cradle for Apple iPad Pro 12.9 (1<sup>st</sup> & 2<sup>nd</sup> Gen)





## Features

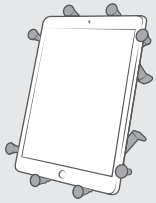

Steel, spring-loaded arms keep tablets secure

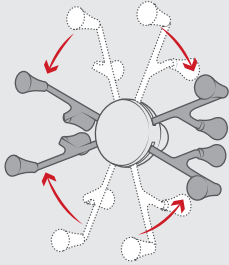

Highly adjustable to support tablets in portrait and landscape mode

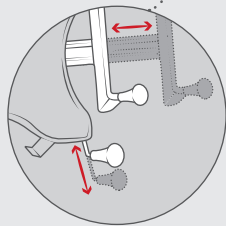
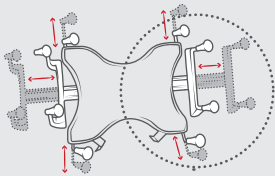

Additional grip handles for convenient insertion and removal



Fits all tablets 7"-12" with or without a case

## Tablet Holders Continued

# RAM® X-Grip®

The RAM® X-Grip® for tablets is the most durable universal holder on the market. The spring-loaded arms expand and contract to provide a perfect fit for your tablet with or without a case. Available for tablets of all sizes, the RAM® X-Grip® holder secures your device from all angles while keeping it completely functional and accessible. No matter what mounting base you pair the RAM® X-Grip® with, the RAM® ball and socket technology allows for near-infinite adjustability and extends the life of your tablet with vibration damping capabilities.



### RAM-HOL-UN8BU

RAM® X-Grip® Universal Holder for 7"-8" Tablets with Ball



**BEST SELLER**

### RAM-HOL-UN9U

RAM® X-Grip® Universal Holder for 9"-10" Tablets



### RAM-HOL-UN11U

For 11"-12" Tablets

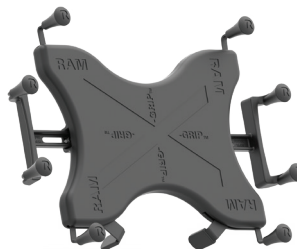



**SEEN IN THIS PHOTO:**

**RAM-B-121-TAB12U**

RAM® Tab-Tite™ Yoke  
Clamp Mount for iPad mini  
for Heavy Duty Cases





## Features

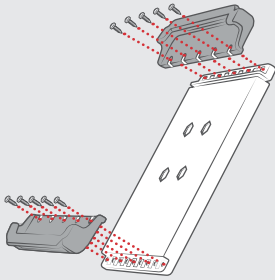

Interchangeable cups support any tablet

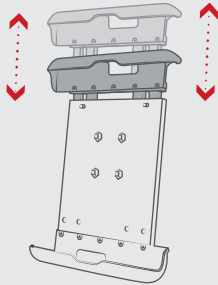

Highly Adjustable

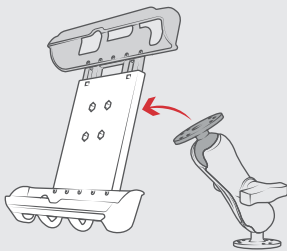

Compatible with B and C size RAM® round ball bases for attaching a double socket arm; ball and socket technology allows for near-infinite adjustability

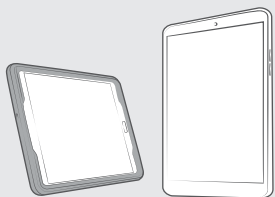

Supports tablets in portrait and landscape mode

## Tablet Holders Continued

# RAM® Tab-Tite™

The RAM® Tab-Tite™ spring-loaded, quick release holder offers a secure fit with easy access to the mounted tablet. The spring-loaded design makes it easy to insert and remove your tablet, while keeping it secure in a variety of applications. The custom end cups are designed to optimize the functionality of your tablet, enabling access to all buttons, ports, and accessories.



For iPads with Case



**BEST  
SELLER**

**RAM-HOL-TAB20U**

iPad 7<sup>th</sup>-9<sup>th</sup> Gen, iPad Air 3



**RAM-HOL-TAB17U**

iPad Air 4 & 5, & Pro 11" 1<sup>st</sup>-3<sup>rd</sup> Gen



**RAM-HOL-TAB29U**

iPad mini 4 & 5



**RAM-HOL-TAB12U**

iPad mini 6



For iPads without Case



**RAM-HOL-TAB26U**

iPad 7<sup>th</sup>-9<sup>th</sup> Gen, iPad Air 3



**RAM-HOL-TAB30U**

iPad Air 4 & 5, & Pro 11" 1<sup>st</sup>-3<sup>rd</sup> Gen



**RAM-HOL-TAB30U**

iPad mini 4 & 5



**RAM-HOL-TAB20U**

iPad mini 6



SEEN IN THIS PHOTO:

**RAM-HOL-MP1U**

RAM® Multi-Pad™

Universal Notepad Holder

WWW.RAM-MOUNT.COM

**RAM**  
MOUNTS.



## Features

Slot for inserting 5" notepads

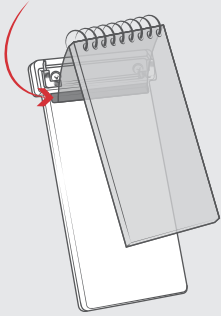

Spring-loaded clip for loose documents

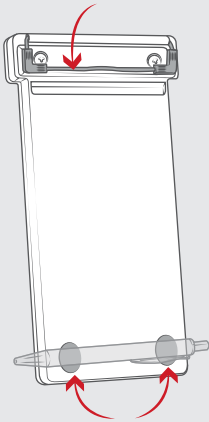

Integrated magnets for holding your ferrous metal pen securely without the need for clips

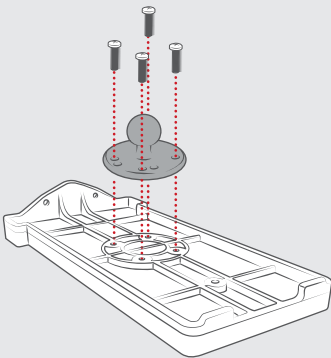

Utilizes multiple mounting points so it can be easily attached to a wide variety of RAM® mounting solutions with the universal AMPS hole pattern

# RAM® Multi-Pad™ Universal Notepad Holder

Whether you're writing clearances, coordinates, or just taking little notes while in-air, the RAM® Multi-Pad™ keeps notetaking accessible. This fully functional notepad mount comes equipped with RAM® compatibility, slot inserts for 5" notepads, and magnetic holder points for the included RAM® pen.

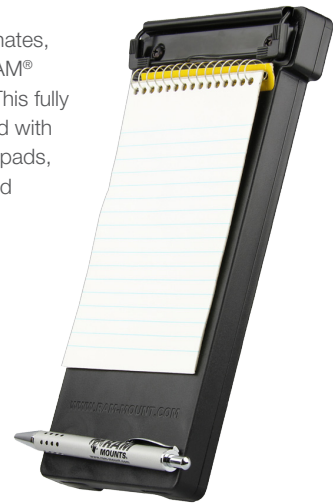

### RAM-HOL-MP1U

RAM® Multi-Pad™ Universal Notepad Holder



### RAM-B-121-MP1U

RAM® Multi-Pad™ with Yoke Clamp Mount



### RAM-B-166-MP1U

RAM® Multi-Pad™ Mount with  
RAM® Twist-Lock™ Suction Cup Base



### RAM-B-177-MP1U

RAM® Multi-Pad™ with  
Glare Shield Clamp Mount

## Form-Fit



Camera Exposed

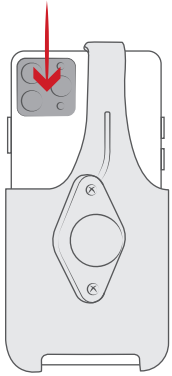

Price



Without Case



One-Handed Operation

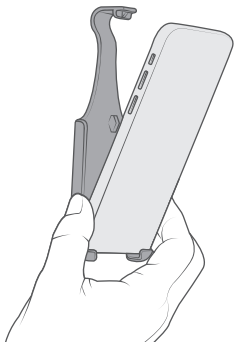

## RAM® Quick-Grip®



Camera Blocked  
Depending on Model

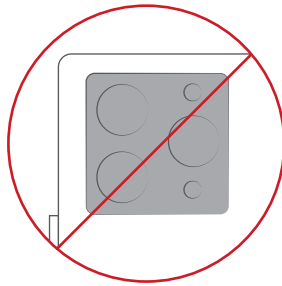

Price



With or Without Case



One-Handed Operation

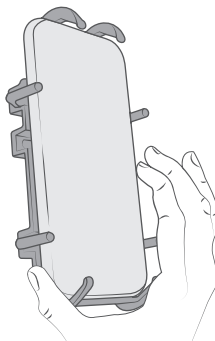

## RAM® X-Grip®



Camera Exposed  
\*Without Tether

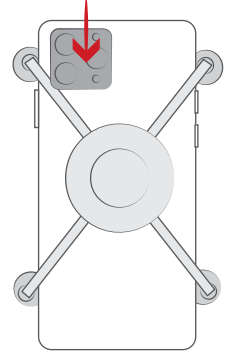

Price



With or Without Case



Two-Handed Operation

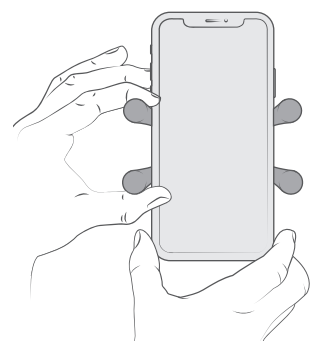



## Features

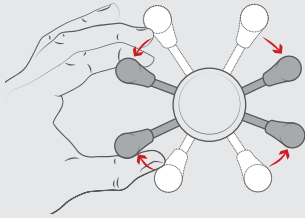

RAM® X-Grip® phone holder features an 'X' design that expands and contracts to provide a perfect fit for your device – even if it's in a case

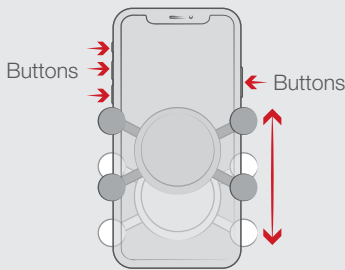

The 'X' design in RAM® X-Grip® can move up and down to expose any buttons

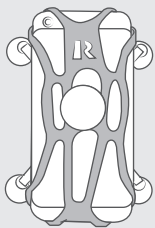
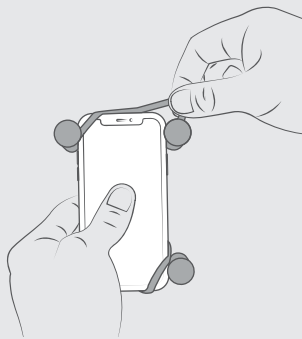

Includes safety tether for extra peace of mind

# Phone Holders

## RAM® X-Grip®

The RAM® X-Grip® is the most durable universal phone holder on the market. The spring-loaded arms expand and contract to provide a perfect fit for your phone with or without a case. Available for cellphones of all sizes, the RAM® X-Grip® cradle secures your device while keeping it completely functional and accessible. No matter what mounting base you pair the RAM® X-Grip® with, the RAM® ball and socket technology allows for near-infinite adjustability and extends the life of your phone with vibration damping capabilities.

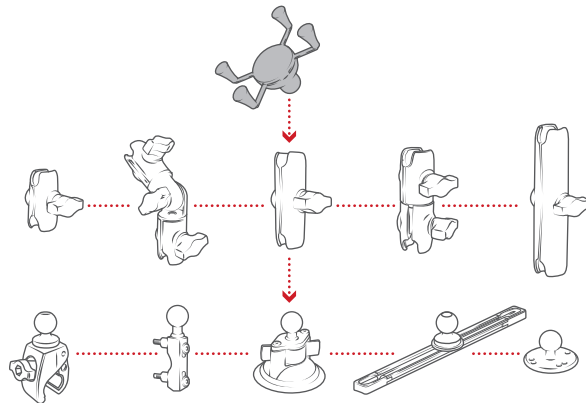

Compatible and interchangeable with a wide range of popular RAM® mounting products



**RAM-HOL-UN7BU**  
RAM® X-Grip® Universal Phone Holder with Ball



Minimum Width: 1.875"



Maximum Width: 3.25"



**BEST SELLER**  
**RAM-HOL-UN10BU**  
RAM® X-Grip® Large Phone Holder with Ball

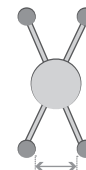

Minimum Width: 1.75"

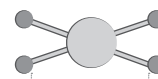

Maximum Width: 4.5"





SEEN IN THIS PHOTO:

**RAP-B-166-PD4U**

RAM® Quick-Grip™ XL Phone Mount  
with RAM® Twist-Lock™ Suction Cup



## Features

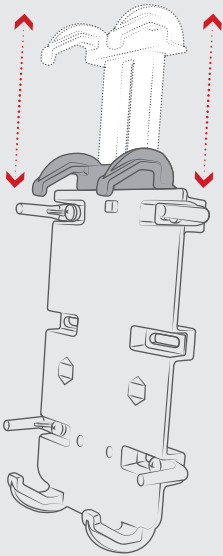

Highly adjustable

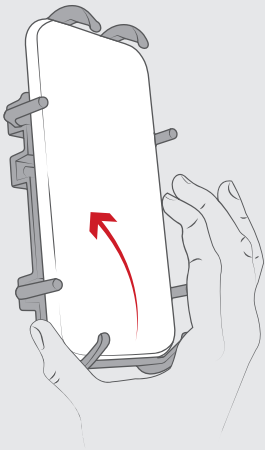

One-handed docking and removal

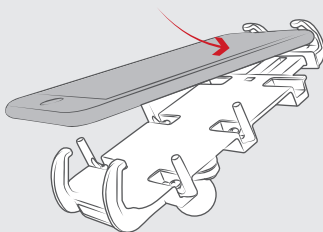

Spring-loaded top grip keeps device in place

## Phone Holders Continued

### RAM® Quick-Grip™

Capable of holding a broad range of electronics, the spring-loaded grips provide a secure fit for your phone with or without a case. Take advantage of efficient one-handed docking and removal of your device no matter if the cellphone is in portrait, or landscape. The adjustable side support arms add extra security and can shift to fit the width of your device perfectly. Available for standard size phones and larger models.

Adjustable side fingers for wider devices can move to expose any buttons

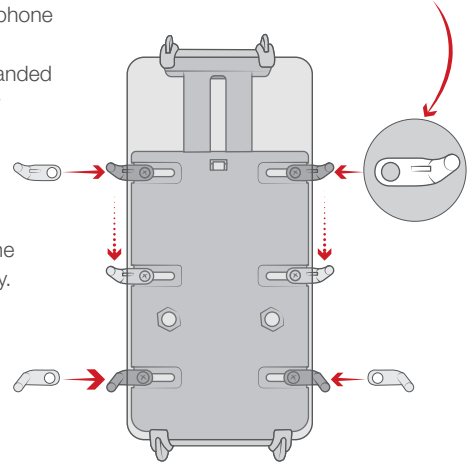

**RAM-HOL-PD3-238AU**  
Small Phone Holder  
with Ball

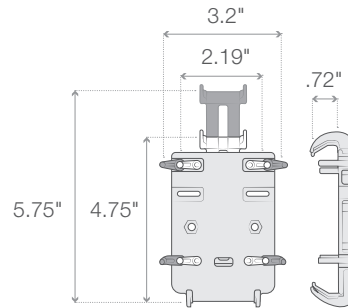

**RAM-HOL-PD4-238AU**  
Large Phone Holder  
with Ball

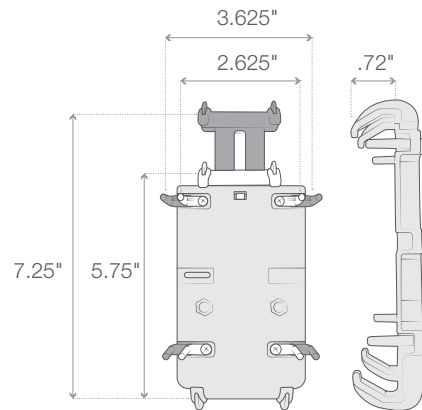

**BEST  
SELLER**



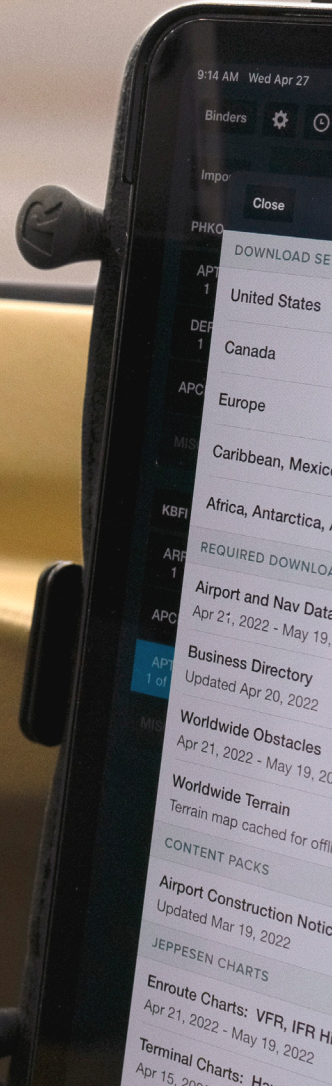

**SEEN IN THIS PHOTO:**

**RAM-HOL-AP35BU**

RAM® Form-Fit Cradle for Apple iPhone 12 & 13 Pro Max with Ball

**RAM-B-166-103U**

RAM® Twist-Lock™ Suction Cup Base with Double Socket Arm



## Features

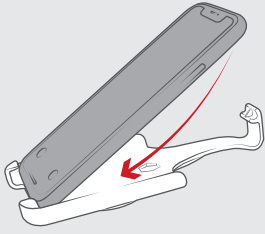

Designed to provide a perfect fit to the device without a case

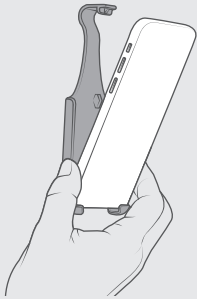

One-handed operation

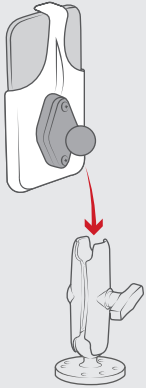

Compatible with B and C size RAM® diamond ball bases for attaching a double socket arm

Camera exposed

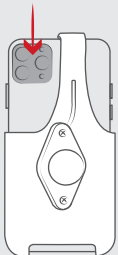

## Phone Holders Continued

### Form-Fit Phone Holders

These high-strength composite, form-fit cradles were designed specifically for the Apple and Samsung devices. Allowing for one-handed docking and removal, all buttons, cameras, ports, and speakers are left exposed. With the two-hole AMPS pattern on the back of each cradle, attach to a RAM® diamond ball base and additional RAM® components.



#### RAM-HOL-AP35BU

RAM® Form-Fit Cradle for Apple iPhone 12 & 13 Pro Max with Ball



#### RAM-HOL-AP35U

RAM® Form-Fit Cradle for Apple iPhone 12 Pro Max & 13 Pro Max



#### RAM-HOL-AP33U

RAM® Form-Fit Cradle for Apple iPhone 12 & 12 Pro



#### RAM-HOL-AP29U

RAM® Form-Fit Cradle for Apple iPhone 11 Pro



#### RAM-HOL-AP28U

RAM® Form-Fit Cradle for Apple iPhone 11



#### RAM-HOL-AP30U

RAM® Form-Fit Cradle for Apple iPhone 11 Pro Max



#### RAM-HOL-SAM59U

RAM® EZ-Roll'r™ Cradle for Samsung XCover Pro





SEEN IN THIS PHOTO:

**RAM-B-166-A-GOP1U**  
RAM® Twist-Lock™ Suction  
Cup Mount with Universal  
Action Camera Adapter





## Features

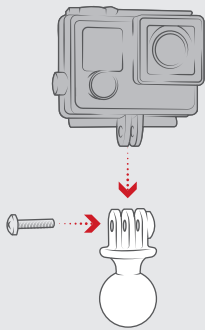

Supports all action cameras with hinge adapter

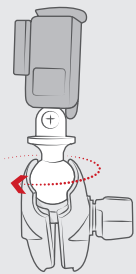
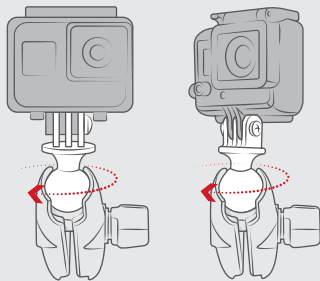

Adjustable position of camera with the turn of a single knob

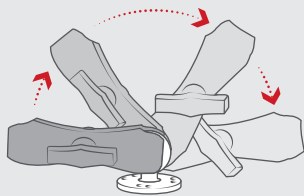

Double ball and socket technology allows for near-infinite adjustability of your RAM® mounting system

# Camera Adapters

Capture the best photos and video possible with the help of RAM® Mounts camera ball adapters, allowing for the perfect angle and a secure hold. Constructed with the highest quality materials, the RAM® ball design dampens shock and vibration to help the camera's image stabilization for a smooth video. The GoPro® base adapter is specifically designed for GoPro® action cameras and easily replaces the factory mount by combining it with a RAM® Mounts socket arm for adjustable 360 degree rotation of your camera with no hassle.

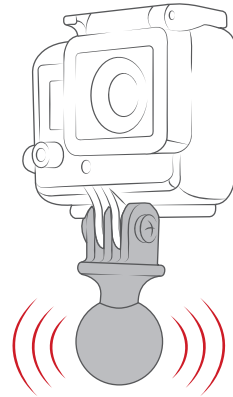

Rubber ball dampens shock and vibration



### RAM-B-166-A-GOP1U

RAM® Twist-Lock™ Suction Cup Mount with Universal Action Camera Adapter



### RAM-B-GOP2-A-GOP1U

RAM® Ball Adapter for GoPro® Bases with Universal Action Camera Adapter



### RAM-B-202U-GOP1

RAM® Action Camera Universal Ball Adapter



### RAM-B-138-GOP1U

RAM® Drill-Down Mount with Universal Action Camera Adapter





**SEEN IN THIS PHOTO:**

**RAM-B-177-202U**

RAM® Glare Shield Clamp Double Ball Mount with Round Plate

**RAM-HOL-GA38U**

RAM® Form-Fit Cradle for Garmin 695 & 696



## Features

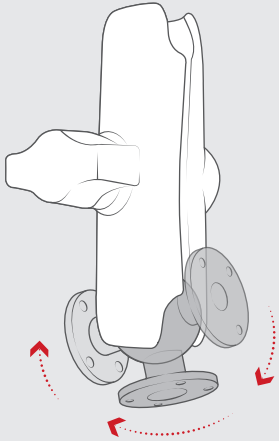

Rubber ball allows for connection to any B size RAM® double socket arm; ball and socket technology allows for near-infinite adjustability

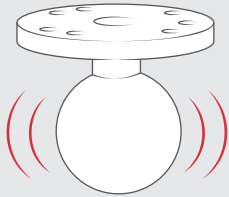

Absorbs shock and vibration

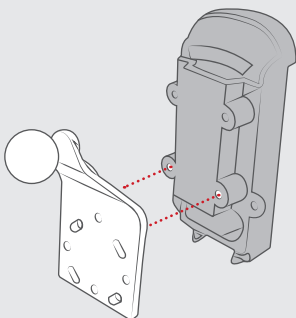

The RAM-B-125BU has predrilled holes for many different screw hole patterns, including the universal AMPS hole pattern that makes it possible to connect to the back of a GPS

## GPS

For aviation-specific GPS devices such as the Garmin 695, the form-fit and EZ-Roll'r™ designs carry over to these devices with RAM® compatibility—allowing you to navigate safely and hands-free. Widescreen GPS devices can also take advantage of the locking holders that provide extra protection and have extra space in the back for Garmin power accessory.

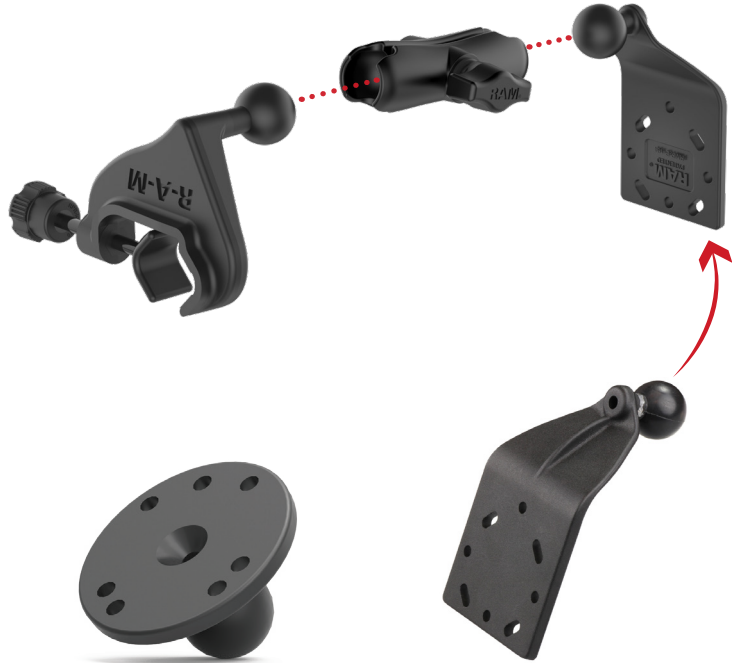

### RAM-B-202U

RAM® Round Plate with Ball for Garmin Aera 796

### RAM-B-125BU

RAM® Curved Extension Base with Ball



### RAM-HOL-GA7U

RAM® Form-Fit Cradle for Garmin GPSMAP 176, 196, 276C, 396, 496 + More



### RAM-HOL-GA38U

RAM® Form-Fit Cradle for Garmin 695 & 696

**SEEN IN THIS PHOTO:**

**RAM-B-166-326-VIS-G1U**

RAM® Twist-Lock™ Suction Cup Mount with Swivel Socket Arm & Sun Visor





## Features

The dark green 50% tint is ideal for blocking sun and glare in a variety of applications

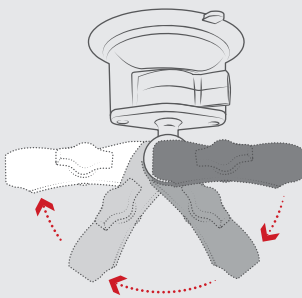
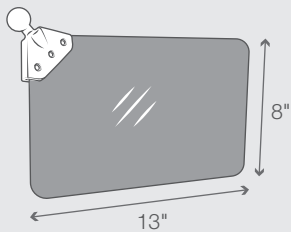
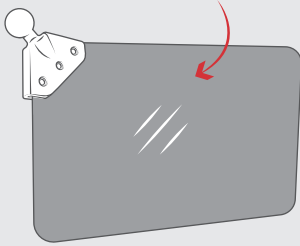

Double ball and socket technology allows for near-infinite adjustability of your RAM® mounting system

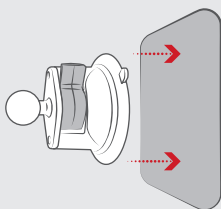

Holds strong against any windshield or non-porous surface

# Sun Visor Accessory

The precision laser cut cast acrylic sun visor offers ideal blockage of glare while ensuring no obstruction or distortion of view while in-air. The dark green 50% tint is ideal for blocking sun and glare with added adjustability using the RAM® ball and socket system. This sun visor includes a 1" B size ball which can be connected to any 1" RAM® socket arm and easily configured for left or right-handed use, as well as pilot and co-pilot use.

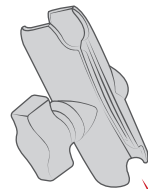

The RAP-393-G1U includes a 1" ball which can be connected to any 1" RAM® socket arm and easily configured for left or right handed use as well as pilot and co-pilot use.

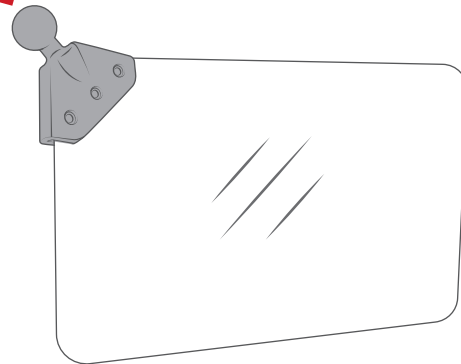

**RAP-393-G1U**  
RAM® Sun Visor with Ball Adapter

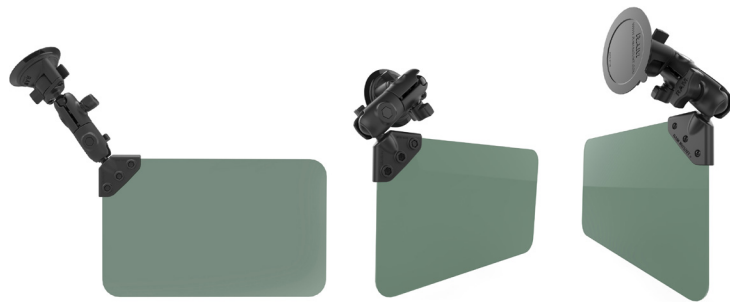

**RAM-B-166-326-VIS-G1U**  
RAM® Twist-Lock™ Suction Cup Mount with Swivel Socket Arm & Sun Visor





SEEN IN THIS PHOTO:

**RAM-B-121-TAB2U**  
RAM® Tab-Tite™ Yoke Clamp  
Mount for iPad mini Series + More



## Features

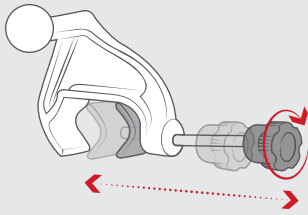

The yoke clamp base will fit rails in diameter from 0.625" to a maximum of 1.25"

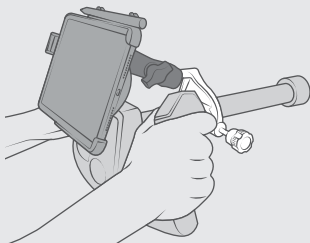
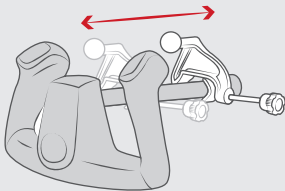
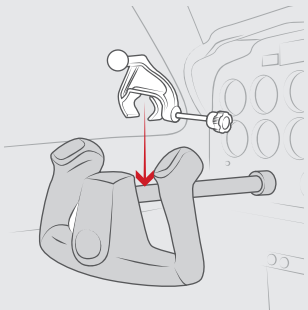

The 1" rubber ball is at a right angle to the plane of the mount; when connected to a rail, the ball sits parallel to the rail, it allows to position forward and back and with the ball and socket technology you simply add your holder

# Yoke Mounts Cessna & Piper

A perfect match for the yokes of Cessna and Piper planes, this clamping base tightens with the turn of a knob and features a RAM® rubber ball. Choose a complete mounting kit or build your own mounting system—just choose a compatible double socket arm and device holder for your phone, tablet, or GPS unit.

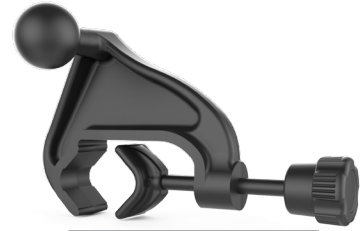

**RAM-B-121BU**  
RAM® Yoke Clamp Base  
with Ball



**RAM-B-121-202U**  
RAM® Double Ball Yoke Clamp Mount  
with Round Plate



**RAM-B-121-238U**  
RAM® Double Ball Yoke Clamp Mount  
with Diamond Plate



**RAM-B-121-TAB2U**  
RAM® Tab-Tite™ Yoke Clamp Mount  
for iPad mini Series + More



**RAM-B-121-TAB12U**  
RAM® Tab-Tite™ Yoke Clamp Mount  
for iPad mini Series + More



**RAM-B-121-GA38U**  
RAM® Double Ball Yoke Clamp Mount  
for Garmin 695 & 696



**RAM-B-121-MP1U**  
RAM® Multi-Pad™ with  
Yoke Clamp Mount



**SEEN IN THIS PHOTO:**

**RAM-HOL-TAB20U**

RAM® Tab-Tite™ Holder for 9"-10.5"  
Tablets with Heavy Duty Cases

**RAM-B-202U**

RAM® Round Plate with Ball

**RAM-B-201U**

RAM® Double Socket Arm

**RAM-B-108B-STRAP40U**

RAM® Large Strap Hose Clamp Base  
for Beechcraft and Bonanza Airplanes



## Features

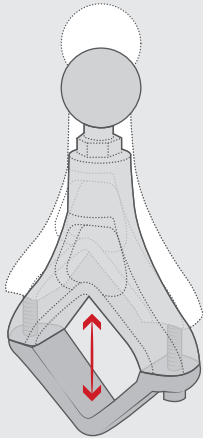

The yoke clamp base accommodates an outer diameter range of 1.25" – 1.625".

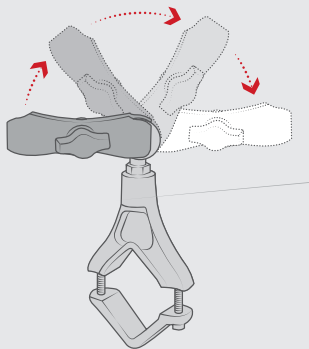

Double ball and socket technology allows for near-infinite adjustability of your RAM® mounting system

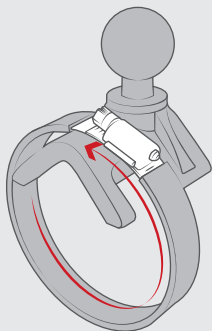

Adjustable to accommodate rails from 2" to a maximum of 3" in diameter.

## Yoke Mounts Continued

# Pilatus PC-12 NG, Beechcraft Bonanza & Throw Over Yokes

Yokes designed for Beechcraft and Pilatus planes are a little more complicated. Of course, RAM® offers yoke mounts designed specifically to fit these complex yoke shapes, but also include the throw over base that offers an optimal viewing angle of your tablet without interfering with flight controls and creating a low-profile experience.



## Pilatus PC-12 NG



**RAM-B-380U**  
RAM® Round Plate with Ball

**RAM-B-380-A-125BU**  
RAM® Yoke Clamp Mount with Curved Plate

## Beechcraft Bonanza & Throw Over Yokes



**RAM-B-108B-STRAP40U**  
RAM® Large Strap Hose Clamp Base  
for Beechcraft Bonanza Airplanes



**SEEN IN THIS PHOTO:**

---

**RAM-B-189B-PIV1U**

RAM® Twist-Lock™ Dual Pivot  
Suction Cup Base with Ball

**RAM-B-201U**

RAM® Double Socket Arm

**RAM-HOL-UN8BU**

RAM® X-Grip® Universal Holder  
for 7"-8" Tablets with Ball



## Features

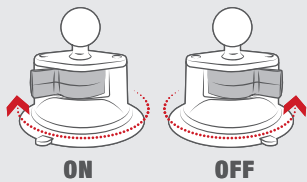

Patented RAM® Twist-Lock™ suction design

Double ball and socket technology allows for near-infinite adjustability of your RAM® mounting system

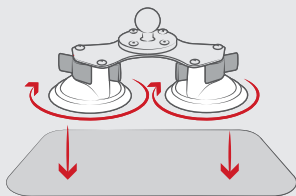
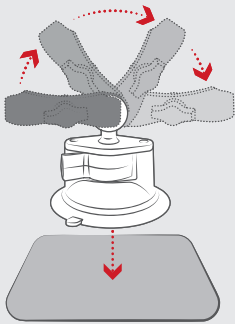

Holds strong against any windshield or non-porous surface

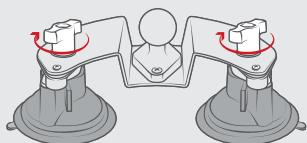

RAM-B-189B-PIV1U has the ability to independently articulate each suction cup, this mounting base can be used in a variety of applications such as curved windows and surfaces

# Windshield Mounting RAM® Twist-Lock™ Suction Cup

The RAM® Twist-Lock™ Suction Cup has a strong hold on glass and non-porous surfaces. Pair it with your favorite action camera, or with the universal RAM® X-Grip® phone cradle for a safe and accessible solution for phones of all sizes.



**BEST SELLER**

**RAM-B-224-1U**  
RAM® Twist-Lock™ Suction Cup Base with Ball



**RAM-B-189B-202U**  
RAM® Twist-Lock™ Dual Suction Cup Base with Ball



**RAM-B-189B-PIV1U**  
RAM® Twist-Lock™ Dual Pivot Suction Cup Base with Ball



**RAM-B-166-UN7U**  
RAM® X-Grip® Phone Mount with RAM® Twist-Lock™ Suction Cup



**RAM-B-166-UN10U**  
RAM® X-Grip® Large Phone Mount w/ RAM® Twist-Lock™ Suction Cup Base



**RAM-B-166-C-UN10U**  
RAM® X-Grip® Large Phone Mount w/ RAM® Twist-Lock™ Suction Cup Base and Long Arm



**RAM-B-166-UN8U**  
RAM® X-Grip® with RAM® Twist-Lock™ Suction Cup Mount for 7"-8" Tablets

SEEN IN THIS PHOTO:

**RAM-B-166-AP20U**

RAM® Twist-Lock™ Suction Cup Mount for Apple iPad mini 4 & 5





## Features

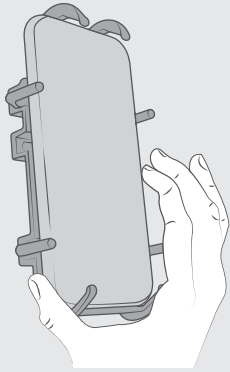

One-handed operation

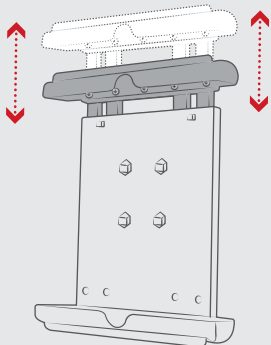

Highly adjustable

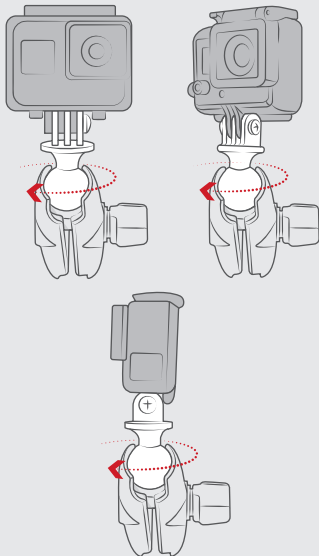

Adjustable position of camera with the turn of a single knob

## Windshield Mounting Continued

# RAM® Twist-Lock™ Suction Cup Kits

Each RAM® Twist-Lock™ suction cup has kits available for those who don't need to build a custom mount themselves. These kits have been put together using customer feedback on popularity of components used to build mounts over the last few decades. RAM® aims to provide both options to build your own, and options to easily buy what already works.



**RAM-B-166-AP36U**  
RAM® Twist-Lock™ Suction Cup Mount for Apple iPad mini 6



**RAM-B-166-PD4U**  
RAM® Quick-Grip™ XL Phone Mount with RAM® Twist-Lock™ Suction Cup



**RAM-B-166-UN7U**  
RAM® X-Grip® Phone Mount with RAM® Twist-Lock™ Suction Cup



**RAM-B-166-TAB12U**  
RAM® Tab-Tite™ with RAM® Twist-Lock™ Suction Cup for iPad mini with Case



**RAM-B-166-TAB20U**  
RAM® Tab-Tite™ Suction Cup Mount for 9"-10.5" Tablets with Case



**RAM-B-166-202U**  
RAM® Twist-Lock™ Suction Cup Double Ball Mount with Round Plate



**RAM-B-166-GOP1U**  
RAM® Twist-Lock™ Suction Cup Mount with Universal Action Camera Adapter

SEEN IN THIS PHOTO:

**RAM-BM-L1-SB1-TAB2U**

RAM® Tab-Tite™ with Kneeboard  
Mount for iPad mini Series + More





## Features

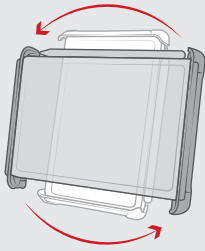

Easily position any aviation tablet mount between portrait or landscape mode

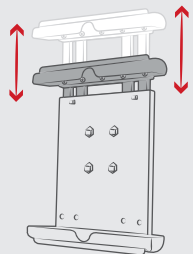

Highly adjustable

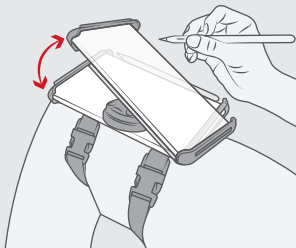

Kneeboard leg mount allows easy angling of tablet to avoid sun glare

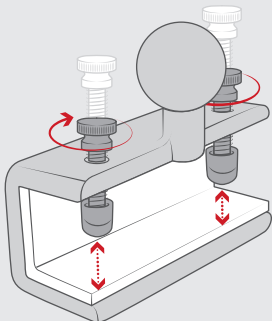

The base has two composite bolts that, when tightened, clamp the base to the lip surface

# Kneeboard Mounts

Don't want to mount to the plane itself? RAM® offers kneeboard mounts you can strap straight to your leg. With 360 degrees of rotation and 45 degrees of tilt, you can position your tablet at the optimal viewing angle during flight.



**RAM-BM-L1-SB1-TAB12U**  
RAM® Tab-Tite™ with  
Kneeboard Mount



**RAM-BM-L1-SB1-TAB2U**  
RAM® Tab-Tite™ with  
Kneeboard Mount



**RAM-BM-L1-SB1U**  
RAM® Snap-Link™ Rotating Leg Mount



**RAM-BM-L1**  
RAM® Body Mount for Legs

# Panel & Glare Shield Mounts

Usually if you're big fans of RAM® Mounts you'll find that you'll literally mount anything, and that quickly turns your cockpit into a field of devices. That's why RAM® develops bases to get every inch of space and mount that one last device.



**RAM-B-259U**  
RAM® Glare Shield Clamp Ball Base



**RAM-B-202U**  
RAM® Round Plate with Ball





SEEN IN THIS PHOTO:

**RAM-B-189-PIV1-TAB20-ALA1-KRU**  
RAM® Tab-Tite™ with RAM® Twist-Lock™  
Dual Suction for Tablets with Cases



## Features

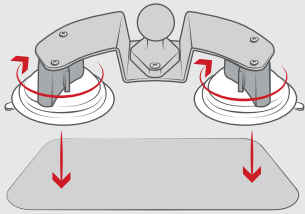

Holds strong against any windshield or non-porous surface

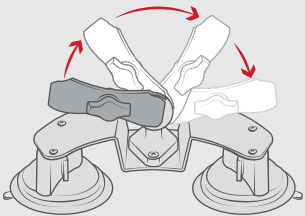

Double ball and socket technology allows for near-infinite adjustability of your RAM® mounting system

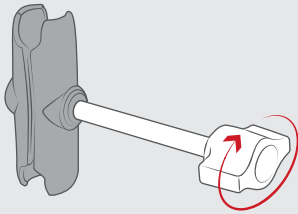

Extended knob allows for convenient access when adjusting tablet

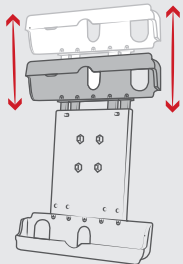

Extended knob allows for convenient access when adjusting tablet

# Commercial Aviation

RAM® doesn't just design and manufacture mounts for recreational flying, RAM® is trusted in the commercial space as well. The same mounts are trusted in the cockpits from all major airlines. The business of passenger and cargo travel is serious business and requires products that are built to last. The entire aviation lineup of RAM® Mounts can be found in almost every large aircraft and has been helping pilots navigate since the '90s.

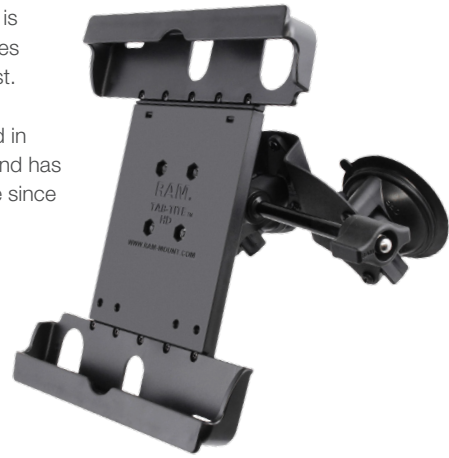

### RAM-B-189-TAB20-ALA1-KRU

RAM® Tab-Tite™ with  
RAM® Twist-Lock™ Suction  
for 9"-10.5" Tablets



### RAM-333-224-1-ALA1-TAB20U

RAM® Tab-Tite™ with RAM® Twist-  
Lock™ Triple Suction for  
9"-10.5" Tablets



### RAM-B-189-UN9-ALA1-KRU

RAM® X-Grip® with  
RAM® Twist-Lock™ Dual Suction for  
9"-10" Tablets



### RAM-B-189-UN8-ALA1-KRU

RAM® X-Grip® with  
RAM® Twist-Lock™ Dual Suction for  
7"-8" Tablets





**SEEN IN THIS PHOTO:**

**RAM-B-131-202**

RAM® Cessna Seat Rail Mount with 12" Flex Arm and Round Plate

**RAM-HOL-TAB20U**

RAM® Tab-Tite™ Holder for 9"-10.5" Tablets with Heavy Duty Cases



## Features

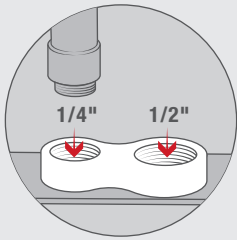

It has two threaded holes, the larger one is a 1/2" NPT hole and the smaller one is 1/4" NPT hole so it accepts any NPT Pipe or NPSM threaded rods offered by RAM®

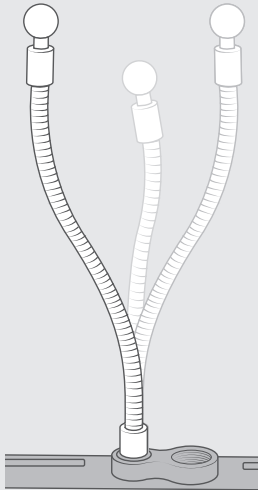

The flex rod is rigid but can be bent to the desired position so that the device can be angled at the ideal position

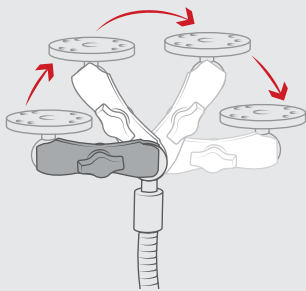

Double ball and socket technology allows for near-infinite adjustability of your RAM® mounting system

# RAM® Cessna Seat Rail Mount with 12" Flex Arm and Round Plate

RAM® brings the popular RAM® No-Drill™ seat bases to airplanes. Much like cars and trucks, airplanes like Cessna have seat rails to adjust the position of the seat. RAM®, of course makes a custom mounting solution that installs directly into the rail system with an included flex rod for the ultimate adjustability and tablet placement to benefit the pilot during flight.

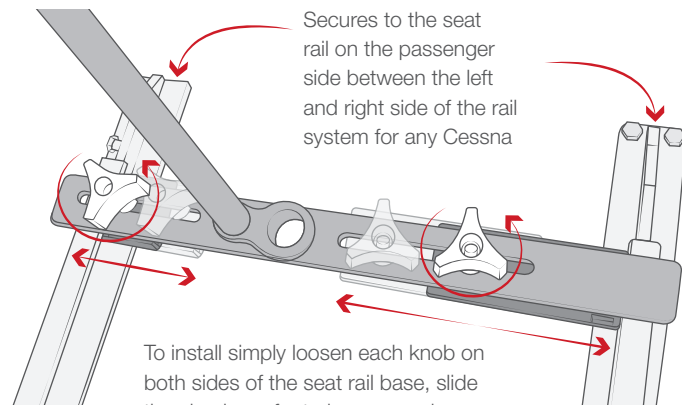

**RAM-B-131-202**

RAM® Cessna Seat Rail Mount with 12" Flex Arm and Round Plate





## CONTACT US

sales@rammount.com

1-800-497-7479

## JOIN OUR COMMUNITY



**NPI-CAT-AVIATION22**

May 2022

